

TIPS VENDOR AGREEMENT (Part 1)

TIPS RFP 240504 SHELTERS FOR STORM, ACTIVE SHOOTER, AND OTHER EMERGENCIES (PART 1)

The following Vendor Agreement (“Agreement”) creates a legal agreement between The Interlocal Purchasing System (“TIPS”), a government purchasing cooperative and Department of Texas Region 8 Education Service Center and (INSERT ENTITY NAME):

Sunsafe Film LLC

(ENTER ENTITY NAME]

its owners, agents, subsidiaries, and affiliates (together, “Vendor”) (individually, “Party”, and collectively the “Parties”) and this agreement shall exclusively govern the contractual relationship (“Agreement”) between the Parties for Part 1 of the related solicitation opportunity. If Vendor proposes and is awarded on Part 2, a separate Part 2 Vendor Agreement shall control Part 2 terms.

TIPS, a governmental entity and a national purchasing cooperative seeks to provide a valuable and necessary solution to public entities and qualifying non-profits by performing the public procurement solicitation process and awarding compliant contracts to qualified vendors. Then, where the law of a customer’s jurisdiction allows, instead of public entities and qualifying non-profits expending time, money, and resources on the extensive public procurement process, the use of TIPS allows public entities to quickly select and purchase their preferred products or services from qualified, competitively evaluated vendors through cooperative purchasing.

1. **Purpose.** The purpose of this Agreement is to identify the terms and conditions of the relationship between TIPS and Vendor. Public entities and qualifying non-profits that properly join or utilize TIPS (“TIPS Members”) may elect to “piggyback” off of TIPS’ procurements and agreements where the laws of their jurisdiction allow. TIPS Members are not contractual parties to this Agreement although terms and conditions of this Agreement may ensure benefits to TIPS Members.
2. **Authority.** The Parties agree that the signatories below are individual authorized to enter into this Agreement on behalf of their entity and that they are acting under due and proper authority under applicable law.
3. **Definitions.**
 - a. **TIPS Pricing:** The specific pricing, discounts, and other pricing terms and incentives which Vendor submitted and TIPS approved for each respective TIPS Contract awarded to Vendor and all permissible, subsequent pricing updates submitted by Vendor and accepted by TIPS, if any.
 - b. **Authorized Reseller:** A reseller or dealer authorized and added by a Vendor through their online TIPS Vendor Portal to make TIPS sales according to the terms and conditions herein.
4. **Entire Agreement.** This Agreement resulted from TIPS posting a Part 1 “TIPS Solicitation” (RFP, RCSP, RFQ, or other) and Vendor submitting a proposal in response to that posted TIPS Solicitation for evaluation and award. The Parties agree that this Agreement consists of the provisions set forth herein and: (1) The Part 1 TIPS solicitation document resulting in this Agreement; (2) Any Part 1 addenda or clarifications issued in relation to the TIPS solicitation; (3) All Part 1 solicitation information provided to Vendor by TIPS through the TIPS eBid System; (3) Vendor’s entire Part 1 proposal response to the TIPS solicitation including all accepted required attachments, acknowledged notices and certifications, accepted negotiated terms, pricing, accepted responses to questions, and accepted written clarifications of Vendor’s proposal, and; any properly included attachments to this Agreement. All documentation and information listed is hereby incorporated by reference as if set forth herein verbatim. In the event of conflict between the terms herein and one of the incorporated documents the terms and conditions herein shall control.
5. **Vendor’s Specific Warranties, Terms, and License Agreements.** Because TIPS serves public entities and non-profits throughout the nation all of which are subject to specific laws and policies of their jurisdiction, as a matter of standard practice, TIPS does not typically accept a Vendor’s specific “Sale Terms” (warranties, license agreements, master agreements, terms and conditions, etc.) on behalf of all TIPS Members. TIPS may permit Vendor to attach those to this Agreement to display to interested customers what terms may apply to their Supplemental Agreement with Vendor (if submitted by Vendor for that purpose). However, unless this term of the Agreement is negotiated and modified to state otherwise, those specific Sale Terms are not accepted by TIPS on behalf of all TIPS Members and each Member may choose whether to accept, negotiate, or reject those specific Sale Terms, which must be reflected in a separate agreement between Vendor and the Member in order to be effective.

- 6. Vendor Identity and Contact Information.** It is Vendor's sole responsibility to ensure that all identifying vendor information (name, EIN, d/b/a's, etc.) and contact information is updated and current at all times within the TIPS eBid System and the TIPS Vendor Portal. It is Vendor's sole responsibility to confirm that all e-correspondence issued from tips-usa.com, ionwave.net, and tipsconstruction.com to Vendor's contacts are received and are not blocked by firewall or other technology security. Failure to permit receipt of correspondence from these domains and failure to keep vendor identity and contact information current at all times during the life of the contract may cause loss of TIPS Sales, accumulating TIPS fees, missed rebid opportunities, lapse of TIPS Contract(s), and unnecessary collection or legal actions against Vendor. It is no defense to any of the foregoing or any breach of this Agreement that Vendor was not receiving TIPS' electronic communications issued by TIPS to Vendor's listed contacts.
- 7. Initiation of TIPS Sales.** When a public entity initiates a purchase with Vendor, if the Member inquires verbally or in writing whether Vendor holds a TIPS Contract, it is the duty of the Vendor to verify whether the Member is seeking a TIPS purchase. Once verified, Vendor must include the TIPS Contract Number on all purchase communications and sales documents exchanged with the TIPS Member.
- 8. TIPS Sales and Supplemental Agreements.** The terms of the specific TIPS order, including but not limited to: shipping, freight, insurance, delivery, fees, bonding, cost, delivery expectations and location, returns, refunds, terms, conditions, cancellations, order assistance, etc., shall be controlled by the purchase agreement (Purchase Order, Contract, Invoice, etc.) (hereinafter "Supplemental Agreement") entered into between the TIPS Member Customer and Vendor only. TIPS is not a party to any Supplemental Agreement. All Supplemental Agreements shall include Vendor's Name, as known to TIPS, and TIPS Contract Name and Number. Vendor accepts and understands that TIPS is not a legal party to TIPS Sales and Vendor is solely responsible for identifying fraud, mistakes, unacceptable terms, or misrepresentations for the specific order prior to accepting. Vendor agrees that any order issued from a customer to Vendor, even when processed through TIPS, constitutes a legal contract between the customer and Vendor only. When Vendor accepts or fulfills an order, even when processed through TIPS, Vendor is representing that Vendor has carefully reviewed the order for legality, authenticity, and accuracy and TIPS shall not be liable or responsible for the same. In the event of a conflict between the terms of this TIPS Vendor Agreement and those contained in any Supplemental Agreement, the provisions set forth herein shall control unless otherwise agreed to and authorized by the Parties in writing within the Supplemental Agreement.
- 9. Right of Refusal.** Vendor has the right not to sell to a TIPS Member under the awarded agreement at Vendor's discretion unless otherwise required by law.
- 10. Reporting TIPS Sales.** Vendor must report all TIPS Sales to TIPS. If a TIPS sale is initiated by Vendor receiving a TIPS Member's purchase order from TIPS directly, Vendor may consider that specific TIPS Sale reported. Otherwise, with the exception of TIPS Automated Vendors, who have signed an exclusive agreement with TIPS regarding reporting, all TIPS Sales must be reported to TIPS by either: (1) Emailing the purchase order or similar purchase document (with Vendor's Name, as known to TIPS, and the TIPS Contract Name and Number included) to TIPS at tipspo@tips-usa.com with "Confirmation Only" in the subject line of the email within three business days of Vendor's acceptance of the order, or; (2) Within 3 business days of the order being accepted by Vendor, Vendor must login to the TIPS Vendor Portal and successfully self-report all necessary sale information within the Vendor Portal and confirm that it shows up accurately on your current Vendor Portal statement. No other method of reporting is acceptable unless agreed to by the Parties in writing. Failure to report all sales pursuant to this provision may result in immediate cancellation of Vendor's TIPS Contract(s) for cause at TIPS' sole discretion. Please refer to the TIPS [Accounting FAQ's](#) for more information about reporting sales and if you have further questions, contact the Accounting Team at accounting@tips-usa.com.
- 11. TIPS Administration Fees.** The collection of administrative fees by TIPS, a government entity, for performance of these procurement services is required pursuant to Texas Government Code Section 791.011 et. seq. The administration fee ("TIPS Administration Fee") is the amount legally owed by Vendor to TIPS for TIPS Sales made by Vendor. The TIPS Administration Fee amount is typically a set percentage of the amount paid by the TIPS Member for each TIPS Sale, less shipping cost, bond cost, and taxes if applicable and identifiable, which is legally due to TIPS, but the exact TIPS Administration Fee for this Contract is published in the corresponding solicitation and is incorporated herein by reference. TIPS Administration Fees are due to TIPS immediately upon Vendor's receipt of payment, including partial payment, for a TIPS Sale. The TIPS Administration Fee is assessed on the amount paid by the TIPS Member, not on the Vendor's cost or on the amount for which the Vendor sold the item to a dealer or Authorized Reseller. Upon receipt of payment for a TIPS Sale, including partial payment (which renders TIPS Administration Fees immediately due), Vendor shall issue to TIPS the corresponding TIPS Administration Fee payment as soon as possible but not later than thirty-one calendar days following Vendor's receipt of payment. Vendor shall pay TIPS via check unless otherwise agreed to by the Parties in writing. Vendor shall include clear documentation with the issued payment dictating to which sale(s) the amount should be applied. Vendor may create a payment report within their TIPS Vendor Portal which is the preferred documentation dictating to which TIPS Sale(s) the amount should be applied. Failure to pay all TIPS Administration Fees pursuant to this provision may result in immediate cancellation of Vendor's TIPS Contract(s) for cause at TIPS' sole discretion as well as the initiation of collection and legal actions by TIPS against Vendor to the extent permitted by law. Any overpayment of participation fees to TIPS by Vendor will be refunded to the Vendor

within ninety (90) days of receipt of notification if TIPS receives written notification of the overpayment not later than the expiration of six (6) months from the date of overpayment and TIPS determines that the amount was not legally due to TIPS pursuant to this agreement and applicable law. Any notification of overpayment received by TIPS after the expiration of six (6) months from the date that TIPS received the payment will render the overpayment non-refundable. Region 8 ESC and TIPS reserve the right to extend the six (6) month deadline if approved by the Region 8 ESC Board of Directors. TIPS reserves all rights under the law to collect TIPS Administration Fees due to TIPS pursuant to this Agreement.

- 12. Term of the Agreement.** This Agreement with TIPS is for approximately three years with a one-year, consecutive option for renewal as described herein. Renewal options are not automatic and shall only be effective if offered by TIPS at its sole discretion. If TIPS offers a renewal option, the Vendor will be notified via email issued to Vendor's then-listed Primary Contact. The renewal option shall be deemed accepted by Vendor unless Vendor notifies TIPS of its objection to the renewal option in writing and confirms receipt by TIPS.

Actual Effective Date: Agreement is effective upon signature by authorized representatives of both Parties. The Effective Date does not affect the "Term Calculation Start Date."

Term Calculation Start Date: To keep the contract term consistent for all vendors awarded under a single TIPS contract, Vendor shall calculate the foregoing term as starting on the last day of the month that "Award Notifications" are anticipated as published in the Solicitation, regardless of the actual Effective Date.

Example of Term Calculation Start Date: If the anticipated "Award Date" published in the Solicitation is May 22, 2023, but extended negotiations delay award until June 27, 2023 (Actual Effective Date), the Term Calculation Start Date shall be May 31, 2023 in this example.

Contract Expiration Date: To keep the contract term consistent for all vendors awarded under a single TIPS contract, the term expiration date shall be three-years from the Term Calculation Start Date.

Example of Contract Expiration Date: If the anticipated "Award Date" published in the Solicitation is May 22, 2023, but extended negotiations delay award until June 27, 2023 (Actual Effective Date), the Term Calculation Start Date shall be May 31, 2023 and the Contract Expiration Date of the resulting initial "three-year" term, (which is subject to an extension(s)) will be May 31, 2026 in this example.

Option(s) for Renewal: Any option(s) for renewal shall begin on the Contract Expiration Date, or the date of the expiration of the prior renewal term where applicable, and continue for the duration specified for the renewal option herein.

Example of Option(s) for Renewal: In this example, if TIPS offers a one-year renewal and the Contract Expiration Date is May 31, 2026, then the one-year renewal is effective from May 31, 2026 to May 31, 2027.

TIPS may offer to extend Vendor Agreements to the fullest extent the TIPS Solicitation resulting in this Agreement permits.

- 13. TIPS Pricing.** Vendor agrees and understands that for each TIPS Contract that it holds, Vendor submitted, agreed to, and received TIPS' approval for specific pricing, discounts, and other pricing terms and incentives which make up Vendor's TIPS Pricing for that TIPS Contract ("TIPS Pricing"). Vendor confirms that Vendor will not add the TIPS Administration Fee as a charge or line-item in a TIPS Sale. Vendor hereby certifies that Vendor shall only offer goods and services through this TIPS Contract if those goods and services are included in or added to Vendor's TIPS Pricing and approved by TIPS. TIPS reserves the right to review Vendor's pricing update requests as specifically as line-item by line-item to determine compliance. However, Vendor contractually agrees that all submitted pricing updates shall be within the original terms of the Vendor's TIPS Pricing (scope, proposed discounts, price increase limitations, and other pricing terms and incentives originally proposed by Vendor) such that TIPS may accept Vendors price increase requests as submitted without additional vetting at TIPS discretion. Any pricing quoted by Vendor to a TIPS Member or on a TIPS Quote shall never exceed Vendor's TIPS Pricing for any good or service offered through TIPS. TIPS Pricing price increases and modifications, if permitted, will be honored according to the terms of the solicitation and Vendor's proposal, incorporated herein by reference.

- 14. Indemnification of TIPS.** VENDOR AGREES TO INDEMNIFY, HOLD HARMLESS, AND DEFEND TIPS, TIPS MEMBERS, TIPS OFFICERS, TIPS EMPLOYEES, TIPS DIRECTORS, AND TIPS TRUSTEES (THE "TIPS INDEMNITEES") FROM AND AGAINST ALL CLAIMS AND SUITS BY THIRD-PARTIES FOR DAMAGES, INJURIES TO PERSONS (INCLUDING DEATH), PROPERTY DAMAGES, LOSSES, EXPENSES, FEES, INCLUDING COURT COSTS, ATTORNEY'S FEES, AND EXPERT FEES, ARISING OUT OF OR RELATING TO VENDOR'S PERFORMANCE UNDER THIS AGREEMENT (INCLUDING THE PERFORMANCE OF VENDOR'S OFFICERS, EMPLOYEES, AGENTS, AUTHORIZED RESELLERS, SUBCONTRACTORS, LICENSEES, OR INVITEES), REGARDLESS OF THE NATURE OF THE CAUSE OF ACTION, INCLUDING WITHOUT LIMITATION CAUSES OF ACTION BASED UPON COMMON, CONSTITUTIONAL, OR STATUTORY LAW OR BASED IN

WHOLE OR IN PART UPON ALLEGATIONS OF NEGLIGENT OR INTENTIONAL ACTS OR OMISSIONS ON THE PART OF VENDOR, ITS OFFICERS, EMPLOYEES, AGENTS, AUTHORIZED RESELLERS, SUBCONTRACTORS, LICENSEES, OR INVITEES. NO LIMITATION OF LIABILITY FOR DAMAGES FOR PERSONAL INJURY OR PROPERTY DAMAGE ARE PERMITTED OR AGREED TO BY TIPS. APART FROM THIS INDEMNIFICATION PROVISION REQUIRING INDEMNIFICATION OF THE TIPS INDEMNITEES' ATTORNEY'S FEES AS SET FORTH ABOVE, RECOVERY OF ATTORNEYS' FEES BY THE PREVAILING PARTY IS AUTHORIZED ONLY IF AUTHORIZED BY TEX. EDUC. CODE § 44.032(F).

15. **Indemnification and Assumption of Risk – Vendor Data.** VENDOR AGREES THAT IT IS VOLUNTARILY PROVIDING DATA (INCLUDING BUT NOT LIMITED TO: VENDOR INFORMATION, VENDOR DOCUMENTATION, VENDOR'S PROPOSALS, VENDOR PRICING SUBMITTED OR PROVIDED TO TIPS, TIPS CONTRACT DOCUMENTS, TIPS CORRESPONDENCE, VENDOR LOGOS AND IMAGES, VENDOR'S CONTACT INFORMATION, VENDOR'S BROCHURES AND COMMERCIAL INFORMATION, VENDOR'S FINANCIAL INFORMATION, VENDOR'S CERTIFICATIONS, AND ANY OTHER VENDOR INFORMATION OR DOCUMENTATION, INCLUDING WITHOUT LIMITATION SOFTWARE AND SOURCE CODE UTILIZED BY VENDOR, SUBMITTED TO TIPS BY VENDOR AND ITS AGENTS) ("VENDOR DATA") TO TIPS. FOR THE SAKE OF CLARITY, AND WITHOUT LIMITING THE BREADTH OF THE INDEMNITY OBLIGATIONS IN SECTION 14 ABOVE, VENDOR AGREES TO PROTECT, INDEMNIFY, AND HOLD THE TIPS INDEMNITEES HARMLESS FROM AND AGAINST ANY AND ALL LOSSES, CLAIMS, ACTIONS, DEMANDS, ALLEGATIONS, SUITS, JUDGMENTS, COSTS, EXPENSES, FEES, INCLUDING COURT COSTS, ATTORNEY'S FEES, AND EXPERT FEES AND ALL OTHER LIABILITY OF ANY NATURE WHATSOEVER ARISING OUT OF OR RELATING TO: (I) ANY UNAUTHORIZED, NEGLIGENT OR WRONGFUL USE OF, OR CYBER DATA BREACH INCIDENT AND VIRUSES OR OTHER CORRUPTING AGENTS INVOLVING, VENDOR'S DATA, PRICING, AND INFORMATION, COMPUTERS, OR OTHER HARDWARE OR SOFTWARE SYSTEMS, AND; (II) ALLEGATIONS OR CLAIMS THAT ANY VENDOR DATA INFRINGES ON THE INTELLECTUAL PROPERTY RIGHTS OF A THIRD-PARTY OR VENDOR.
16. **Procedures Related to Indemnification.** In the event that an indemnity obligation arises, Vendor shall pay all amounts set forth in Section 14 and 15 above (including any settlements) and – if it has accepted its indemnity obligation without qualification – control the legal defense to such claim or cause of action, including without limitation attorney selection, strategy, discovery, trial, appeal, and settlement, and TIPS shall, at Vendor's cost and expense (with respect to reasonable out of pocket costs and expenses incurred by TIPS which shall be reimbursed to TIPS by Vendor), provide all commercially reasonable assistance requested by Vendor. In controlling any defense, Vendor shall ensure that all assertions of governmental immunity and all applicable pleas and defenses shall be promptly asserted.
17. **Indemnity for Underlying Sales and Supplemental Agreements.** Vendor shall be solely responsible for any customer claims or any disputes arising out of TIPS Sales or any Supplemental Agreement as if sold in the open-market. The Parties agree that TIPS shall not be liable for any claims arising out of Vendor's TIPS Sales or Supplemental Agreements, including but not limited to: allegations of product defect or insufficiency, allegations of service defect or insufficiency, allegations regarding delivery defect or insufficiency, allegations of fraud or misrepresentation, allegations regarding pricing or amounts owed for TIPS sales, and/or allegations regarding payment, over-payment, under-payment, or non-payment for TIPS Sales. Payment/Drafting, overpayment/over-drafting, under-payment/under-drafting, or non-payment for TIPS Sales between customer and Vendor and inspections, rejections, or acceptance of such purchases shall be the exclusive respective obligations of Vendor/Customer, and disputes shall be handled in accordance with the terms of the underlying Supplemental Agreement(s) entered into between Vendor and Customer. Vendor acknowledges that TIPS is not a dealer, subcontractor, agent, or reseller of Vendor's goods and services and shall not be responsible for any claims arising out of alleged insufficiencies or defects in Vendor's goods and services, should any arise.
18. **Confidentiality of Vendor Data.** Vendor understands and agrees that by signing this Agreement, all Vendor Data is hereby released to TIPS, TIPS Members, and TIPS third-party administrators to effectuate Vendor's TIPS Contract except as provided for herein. The Parties agree that Vendor Data is accessible by all TIPS Members as if submitted directly to that TIPS Member Customer for purchase consideration. If Vendor otherwise considers any portion of Vendor's Data to be confidential and not subject to public disclosure pursuant to Chapter 552 Texas Gov't Code (the "Public Information Act") or other law(s) and orders, Vendor must have identified the claimed confidential materials through proper execution of the Confidentiality Claim Form which is required to be submitted as part of Vendor's proposal resulting in this Agreement and incorporated by reference. The Confidentiality Claim Form included in Vendor's proposal and incorporated herein by reference is the sole indicator of whether Vendor considers any Vendor Data confidential in the event TIPS receives a Public Information Request. If TIPS receives a request, any responsive documentation not deemed confidential by you in this manner will be automatically released. For Vendor Data deemed confidential by you in this manner, TIPS will follow procedures of controlling statute(s) regarding any claim of confidentiality and shall not be liable for any release of information required by law, including Attorney General determination and opinion. In the event that TIPS receives a written request for information pursuant to the Public Information Act that affects Vendor's interest in any information or data furnished to TIPS by Vendor, and TIPS requests an opinion from the Attorney General, Vendor may, at its own option and expense, prepare comments and submit information directly to the Attorney General stating why the requested information is exempt from disclosure pursuant to the requirements of the Public Information Act. Vendor is solely responsible for submitting the memorandum brief and information to the Attorney General

within the time period prescribed by the Public Information Act. Notwithstanding any other information provided in this solicitation or Vendor designation of certain Vendor Data as confidential or proprietary, Vendor's acceptance of this TIPS Vendor Agreement constitutes Vendor's consent to the disclosure of Vendor's Data, including any information deemed confidential or proprietary, to TIPS Members or as ordered by a Court or government agency, including without limitation the Texas Attorney General. Vendor agrees that TIPS shall not be responsible or liable for any use or distribution of information or documentation by TIPS Members or as required by law.

- 19. Vendor's Authorized Resellers.** TIPS recognizes that many vendors operate in the open market through the use of resellers or dealers. For that reason, TIPS permits Vendor to authorize Authorized Resellers within its Vendor Portal and make TIPS Sales through the Authorized Reseller(s). Once authorized by Vendor in the Vendor Portal, the Authorized Reseller(s) may make TIPS sales to TIPS Members. However, all purchase documents must include: (1) Authorized Reseller's Name; (2) Vendor's Name, as known to TIPS, and; (3) Vendor's TIPS Contract Name and Number under which it is making the TIPS Sale. Either Vendor or Reseller may report the sale pursuant to the terms herein. However, Vendor agrees that it is legally responsible for all reporting and fee payment as described herein for TIPS Sales made by Authorized Resellers. The TIPS Administration Fee is assessed on the amount paid by the TIPS Member, not on the Vendor's cost or on the amount for which the Vendor sold the item to a dealer or Authorized Reseller. The Parties intend that Vendor shall be responsible and liable for TIPS Sales made by Vendor's Authorized Resellers. Vendor agrees that it is voluntarily authorizing this Authorized Reseller and in doing so, Vendor agrees that it is doing so at its own risk and agrees to protect, indemnify, and hold TIPS harmless in accordance with Sections 14-17 above related to Authorized Reseller TIPS Sales made pursuant to this Agreement or purporting to be made pursuant to this Agreement that may be asserted against Vendor whether rightfully brought or otherwise. The Parties further agree that it is no defense to Vendor's breach of this Agreement that an Authorized Reseller caused Vendor of breach this Agreement.
- 20. Circumvention of TIPS Sales.** When a public entity initiates a purchase with Vendor, if the Member inquires verbally or in writing whether Vendor holds a TIPS Contract, it is the duty of the Vendor to verify whether the Member is seeking a TIPS purchase. Any request for quote, customer communication, or customer purchase initiated through or referencing a TIPS Contract shall be completed through TIPS pursuant to this Agreement. Any encouragement or participation by Vendor in circumventing a TIPS sale being completed may result in immediate termination of Vendor's TIPS Contract(s) for cause as well as preclusion from future TIPS opportunities at TIPS sole discretion.
- 21. State of Texas Franchise Tax.** By signature hereon, Vendor hereby certifies that Vendor is not currently delinquent in the payment of any franchise taxes owed to the State of Texas under Chapter 171 of the Texas Tax Code.
- 22. Termination.**
- A) Termination for Convenience. TIPS may, by written notice to Vendor, terminate this Agreement for convenience, in whole or in part, at any time by giving thirty (30) days' written notice to Vendor of such termination, and specifying the effective date thereof.
 - B) Termination for Cause. If Vendor fails to materially perform pursuant to the terms of this Agreement, TIPS shall provide written notice to Vendor specifying the default. If Vendor does not cure such default within thirty (30) days, TIPS may terminate this Agreement, in whole or in part, for cause. If TIPS terminates this Agreement for cause, and it is later determined that the termination for cause was wrongful, the termination shall automatically be converted to and treated as a termination for convenience.
 - C) Vendor's Termination. If TIPS fails to materially perform pursuant to the terms of this Agreement, Vendor shall provide written notice to TIPS specifying the default ("Notice of Default"). If TIPS does not cure such default within thirty (30) days, Vendor may terminate this Agreement, in whole or in part, for cause. If Vendor terminates this Agreement for cause, and it is later determined that the termination for cause was wrongful, the termination shall automatically be converted to and treated as a termination for convenience.
 - D) Upon termination, all TIPS Sale orders previously accepted by Vendor shall be fulfilled and Vendor shall be paid for all TIPS Sales executed pursuant to the applicable terms. All TIPS Sale orders presented to Vendor but not fulfilled by Vendor, prior to the actual termination of this agreement shall be honored at the option of the TIPS Member. TIPS shall submit to Vendor an invoice for any outstanding TIPS Administration Fees and approved expenses and Vendor shall pay such fees and expenses within 30 calendar days of receipt of such valid TIPS invoice. Vendor acknowledges and agrees that continued participation in TIPS is subject to TIPS' sole discretion and that any Vendor may be removed from the TIPS program at any time with or without cause. This

termination clause does not affect TIPS Sales Supplemental Agreements pursuant to this term regarding termination and the Survival Clause term.

- E) Vendor hereby waives any and all claims for damages, including, but not limited, to consequential damages or lost profits, that might arise from TIPS' act of terminating this Agreement.

- 23. Survival Clause.** It is the intent of the Parties that this Agreement and procurement method applies to any TIPS Sale made during the life of this Agreement even if made on or near the Contract Expiration Date as defined herein. Thus, all TIPS Sales, including but not limited to: leases, service agreements, license agreements, open purchase orders, warranties, and contracts, even if they extend months or years past the TIPS Contract Expiration Date, shall survive the expiration or termination of this Agreement subject to the terms and conditions of the Supplemental Agreement between Customer and Vendor or unless otherwise specified herein.
- 24. Audit Rights.** Due to transparency statutes and public accountability requirements of TIPS and TIPS Members, Vendor shall at their sole expense, maintain documentation of all TIPS Sales for a period of three years from the time of the TIPS Sale. In order to ensure and confirm compliance with this agreement, TIPS shall have authority to conduct audits of Vendor's TIPS Pricing or TIPS Sales with thirty-days' notice unless the audit is ordered by a Court Order or by a Government Agency with authority to do so without said notice. Notwithstanding the foregoing, in the event that TIPS is made aware of any pricing being offered to eligible entities that is materially inconsistent with Vendor's TIPS Pricing, TIPS shall have the ability to conduct the audit internally or may engage a third-party auditing firm to investigate any possible non-compliant conduct or may terminate the Agreement according to the terms of this Agreement. In the event of an audit, the requested materials shall be reasonably provided in the time, format, and at the location acceptable to TIPS. TIPS agrees not to perform a random audit the TIPS transaction documentation more than once per calendar year, but reserves the right to audit for just cause or as required by any governmental agency or court with regulatory authority over TIPS or the TIPS Member. These audit rights shall survive termination of this Agreement for a period of one (1) year from the effective date of termination.
- 25. Conflicts of Interest.** The Parties confirm that they have not offered, given, or accepted, nor intend to give at any time hereafter any economic opportunity, future employment, gift, loan, gratuity, special discount, trip, favor, service to the other in connection with this Agreement. Vendor affirms that, to the best of Vendor's knowledge, this Agreement has been arrived at independently, and is awarded without collusion with anyone to obtain information or gain any favoritism that would in any way limit competition or give an unfair advantage over other vendors in the award of this Agreement. Vendor agrees that it has disclosed any necessary affiliations with Region 8 Education Service Center and the TIPS Department, if any, through the Conflict of Interest attachment provided in the solicitation resulting in this Agreement.
- 26. Volume of TIPS Sales.** Nothing in this Agreement or any TIPS communication may be construed as a guarantee that TIPS or TIPS Members will submit any TIPS orders to Vendor at any time.
- 27. Compliance with the Law.** The Parties agree to comply fully with all applicable federal, state, and local statutes, ordinances, rules, and regulations applicable to their entity in connection with the programs contemplated under this Agreement.
- 28. Severability.** If any term(s) or provision(s) of this Agreement are held by a court of competent jurisdiction to be invalid, void, or unenforceable, then such term(s) or provision(s) shall be deemed restated to reflect the original intention of the Parties as nearly as possible in accordance with applicable law and the remainder of this Agreement, and the remainder of the provisions of this Agreement shall remain in full force and effect and shall in no way be affected, impaired or invalidated, unless such holding causes the obligations of the Parties hereto to be impossible to perform or shall render the terms of this Agreement to be inconsistent with the intent of the Parties hereto.
- 29. Force Majeure.** If by reason of Force Majeure, either party hereto shall be rendered unable wholly or in part to carry out its obligations under this Agreement through no fault of its own then such party shall give notice and full particulars of Force Majeure in writing to the other party within a reasonable time after occurrence of the event or cause relied upon. Upon delivering such notice, the obligation of the affected party, so far as it is affected by such Force Majeure as described, shall be suspended during the continuance of the inability then claimed but for no longer period, and such party shall endeavor to remove or overcome such inability with all reasonable dispatch. In the event that Vendor's obligations are suspended by reason of Force Majeure, all TIPS Sales accepted prior to the Force Majeure event shall be the legal responsibility of Vendor and the terms of the TIPS Sale Supplemental Agreement shall control Vendor's failure to fulfill for a Force Majeure event.
- 30. Immunity.** Vendor agrees that nothing in this Agreement shall be construed as a waiver of sovereign or government immunity; nor constitute or be construed as a waiver of any of the privileges, rights, defenses, remedies, or immunities available to Region 8 Education Service Center or its TIPS Department. The failure to enforce, or any delay in the enforcement of, any privileges, rights, defenses,

remedies, or immunities available to Region 8 Education Service Center or its TIPS Department under this Agreement or under applicable law shall not constitute a waiver of such privileges, rights, defenses, remedies, or immunities or be considered as a basis for estoppel.

- 31. Insurance Requirements.** Vendor agrees to maintain the following minimum insurance requirements for the duration of this Agreement. All policies held by Vendor to adhere to this term shall be written by a carrier with a financial size category of VII and at least a rating of "A-" by A.M. Best Key Rating Guide. The coverages and limits are to be considered minimum requirements and in no way limit the liability of the Vendor(s). Any immunity available to TIPS or TIPS Members shall not be used as a defense by the contractor's insurance policy. Only deductibles applicable to property damage are acceptable, unless proof of retention funds to cover said deductibles is provided. "Claims made" policies will not be accepted. Vendor's required minimum coverage shall not be suspended, voided, cancelled, non-renewed or reduced in coverage or in limits unless replaced by a policy that provides the minimum required coverage except after thirty (30) days prior written notice by certified mail, return receipt requested has been given to TIPS or the TIPS Member if a project or pending delivery of an order is ongoing. Upon request, certified copies of all insurance policies shall be furnished to the TIPS or the TIPS Member. Vendor agrees that when Vendor or its subcontractors are liable for any damages or claims, Vendor's policy, shall be primary over any other valid and collectible insurance carried by the Member or TIPS.

General Liability: \$1,000,000 each Occurrence/Aggregate

Automobile Liability: \$300,000 Includes owned, hired & non-owned

Workers' Compensation: Statutory limits for the jurisdiction in which the Vendor performs under this Agreement. If Vendor performs in multiple jurisdictions, Vendor shall maintain the statutory limits for the jurisdiction with the greatest dollar policy limit requirement.

Umbrella Liability: \$1,000,000 each Occurrence/Aggregate

- 32. Waiver.** No waiver of any single breach or multiple breaches of any provision of this Agreement shall be construed to be a waiver of any breach of any other provision. No delay in acting regarding any breach of any provision shall be construed to be a waiver of such breach.
- 33. Binding Agreement.** This Agreement shall be binding and inure to the benefit of the Parties hereto and their respective heirs, legal successors, and assigns.
- 34. Headings.** The paragraph headings contained in this Agreement are included solely for convenience of reference and shall not in any way affect the meaning or interpretation of any of the provisions of this Agreement.
- 35. Choice of Law and Venue.** This Agreement shall be governed by, construed, and enforced in accordance with the laws of the State of Texas. Any proceeding, claim, action, or alternative dispute resolution arising out of or relating to this Agreement or involving TIPS shall be brought in a State Court of competent jurisdiction in Camp County, Texas, or if Federal Court is legally required, a Federal Court of competent jurisdiction in the Eastern District of Texas, and each of the Parties irrevocably submits to the exclusive jurisdiction of said court in any such proceeding, waives any objection it may now or hereafter have to venue or to convenience of forum, agrees that all claims in respect of the proceeding shall be heard and determined only in any such court, and agrees not to bring any proceeding arising out of or relating to this procurement process or any contract resulting from or and contemplated transaction in any other court. The Parties agree that either or both of them may file a copy of this paragraph with any court as written evidence of the knowing, voluntary and freely bargained for agreement between the Parties irrevocably to waive any objections to venue or to convenience of forum.
- 36. Relationship of the Parties.** Nothing contained in this Agreement shall be construed to make one Party an agent of the other Party nor shall either party have any authority to bind the other in any respect, unless expressly authorized by the other party in writing. The Parties are independent contractors and nothing in this Agreement creates a relationship of employment, trust, agency or partnership between them.
- 37. Assignment.** No assignment of this Agreement or of any duty or obligation of performance hereunder, shall be made in whole or in part by a Party hereto without the prior written consent of the other Party. Written consent of TIPS shall not be unreasonably withheld.
- 38. Minimum Condition and Warranty Requirements for TIPS Sales.** All goods quoted or sold through a TIPS Sale shall be new unless clearly stated otherwise in writing. All new goods and services shall include the applicable manufacturers minimum standard warranty unless otherwise agreed to in the Supplemental Agreement.

- 39. Minimum Customer Support Requirements for TIPS Sales.** Vendor shall provide timely and commercially reasonable support for TIPS Sales or as agreed to in the applicable Supplemental Agreement.
- 40. Minimum Shipping Requirements for TIPS Sales.** Vendor shall ship, deliver, or provide ordered goods and services within a commercially reasonable time after acceptance of the order. If a delay in delivery is anticipated, Vendor shall notify the TIPS Member as to why delivery is delayed and provide an updated estimated time for completion. The TIPS Member may cancel the order if the delay is not commercially acceptable or not consistent with the Supplemental Agreement applicable to the order.
- 41. Minimum Vendor License Requirements.** Vendor shall maintain, in current status, all federal, state, and local licenses, bonds and permits required for the operation of the business conducted by Vendor. Vendor shall remain fully informed of and in compliance with all ordinances and regulations pertaining to the lawful provision of goods or services under the TIPS Agreement. TIPS and TIPS Members reserve the right to stop work and/or cancel a TIPS Sale or terminate this or any TIPS Sale Supplemental Agreement involving Vendor if Vendor's license(s) required to perform under this Agreement or under the specific TIPS Sale have expired, lapsed, are suspended or terminated subject to a 30-day cure period unless prohibited by applicable statute or regulation.
- 42. Minimum Vendor Legal Requirements.** Vendor shall remain aware of and comply with this Agreement and all local, state, and federal laws governing the sale of products/services offered by Vendor under this contract. Such applicable laws, ordinances, and policies must be complied with even if not specified herein.
- 43. Minimum Site Requirements for TIPS Sales (when applicable to TIPS Sale).**

Cleanup: When performing work on site at a TIPS Member's property, Vendor shall clean up and remove all debris and rubbish resulting from their work as required or directed by the TIPS Member or as agreed by the parties. Upon completion of work, the premises shall be left in good repair and an orderly, neat, clean and unobstructed condition.

Preparation: Vendor shall not begin a project for which a TIPS Member has not prepared the site, unless Vendor does the preparation work at no cost, or until TIPS Member includes the cost of site preparation in the TIPS Sale Site preparation includes, but is not limited to: moving furniture, installing wiring for networks or power, and similar pre-installation requirements.

Registered Sex Offender Restrictions: For work to be performed at schools, Vendor agrees that no employee of Vendor or a subcontractor who has been adjudicated to be a registered sex offender will perform work at any time when students are, or reasonably expected to be, present unless otherwise agreed by the TIPS Member. Vendor agrees that a violation of this condition shall be considered a material breach and may result in the cancellation of the TIPS Sale at the TIPS Member's discretion. Vendor must identify any additional costs associated with compliance of this term. If no costs are specified, compliance with this term will be provided at no additional charge.

Safety Measures: Vendor shall take all reasonable precautions for the safety of employees on the worksite, and shall erect and properly maintain all necessary safeguards for protection of workers and the public. Vendor shall post warning signs against all hazards created by the operation and work in progress. Proper precautions shall be taken pursuant to state law and standard practices to protect workers, general public and existing structures from injury or damage.

Smoking: Persons working under Agreement shall adhere to the TIPS Member's or local smoking statutes, codes, ordinances, and policies.

- 44. Payment for TIPS Sales.** TIPS Members may make payments for TIPS Sales directly to Vendor, Vendor's Authorized Reseller, or as otherwise agreed to in the applicable Supplemental Agreement after receipt of the invoice and in compliance with applicable payment statutes. Regardless of how payment is issued or received for a TIPS Sale, Vendor is responsible for all reporting and TIPS Administration Fee payment requirements as stated herein.
- 45. Marketing.** Vendor agrees to allow TIPS to use their name and logo within the TIPS website, database, marketing materials, and advertisements unless Vendor negotiates this term to include a specific acceptable-use directive. Any use of TIPS' name and logo or any form of publicity, inclusive of press release, regarding this Agreement by Vendor must have prior approval from TIPS which will not be unreasonably withheld. Request may be made by email to tips@tips-usa.com. For marketing efforts directed to TIPS Members, Vendor must request and execute a separate Joint Marketing Disclaimer, at marketing@tips-usa.com, before TIPS can release contact information for TIPS Member entities for the purpose of marketing your TIPS contract(s). Vendor must adhere to strict Marketing Requirements once a disclaimer is executed. The Joint Marketing Disclaimer is a supplemental agreement specific to joint marketing efforts and has no effect on the terms of the TIPS Vendor Agreement. Vendor agrees that any images, photos, writing, audio, clip art,

music, or any other intellectual property ("Property") or Vendor Data utilized, provided, or approved by Vendor during the course of the joint marketing efforts are either the exclusive property of Vendor, or Vendor has all necessary rights, license, and permissions to utilize said Property in the joint marketing efforts. Vendor agrees that they shall indemnify and hold harmless TIPS and its employees, officers, agents, representatives, contractors, assignees, designees, and TIPS Members from any and all claims, damages, and judgments involving infringement of patent, copyright, trade secrets, trade or services marks, and any other intellectual or intangible property rights and/or claims arising from the Vendor's (including Vendor's officers', employees', agents', Authorized Resellers', subcontractors', licensees', or invitees') unauthorized use or distribution of Vendor Data and Property.

46. **Tax Exempt Status of TIPS Members.** Most TIPS Members are tax exempt entities and the laws and regulations applicable to the specific TIPS Member customer shall control.
47. **Automatic Renewal Limitation for TIPS Sales.** No TIPS Sale may incorporate an automatic renewal clause that exceeds month to month terms with which the TIPS Member must comply. All renewal terms incorporated into a TIPS Sale Supplemental Agreement shall only be valid and enforceable when Vendor received written confirmation of acceptance of the renewal term from the TIPS Member for the specific renewal term. The purpose of this clause is to avoid a TIPS Member inadvertently renewing an Agreement during a period in which the governing body of the TIPS Member has not properly appropriated and budgeted the funds to satisfy the Agreement renewal. Any TIPS Sale Supplemental Agreement containing an "Automatic Renewal" clause that conflicts with these terms is rendered void and unenforceable.
48. **Choice of Law Limitation for TIPS Sales.** Vendor agrees that if any "Choice of Law" provision is included in any TIPS Sale agreement/contract between Vendor and a TIPS Member, that clause must provide that the "Choice of Law" applicable to the TIPS Sale agreement/contract between Vendor and TIPS Member shall be the state where the TIPS Member operates unless the TIPS Member expressly agrees otherwise. Any TIPS Sale Supplemental Agreement containing a "Choice of Law" clause that conflicts with these terms is rendered void and unenforceable.
49. **Venue Limitation for TIPS Sales.** Vendor agrees that if any "Venue" provision is included in any TIPS Sale Agreement/contract between Vendor and a TIPS Member, that clause must provide that the "Venue" for any litigation or alternative dispute resolution shall be in the state and county where the TIPS Member operates unless the TIPS Member expressly agrees otherwise. Any TIPS Sale Supplemental Agreement containing a "Venue" clause that conflicts with these terms is rendered void and unenforceable.
50. **Indemnity Limitation for TIPS Sales.** Texas and other jurisdictions restrict the ability of governmental entities to indemnify others. Vendor agrees that if any "Indemnity" provision which requires the TIPS Member to indemnify Vendor is included in any TIPS sales agreement/contract between Vendor and a TIPS Member, that clause must either be stricken or qualified by including that such indemnity is only permitted, "to the extent permitted by the laws and constitution of [TIPS Member's State]" unless the TIPS Member expressly agrees otherwise. Any TIPS Sale Supplemental Agreement containing an "Indemnity" clause that conflicts with these terms is rendered void and unenforceable.
51. **Arbitration Limitation for TIPS Sales.** Vendor agrees that if any "Arbitration" provision is included in any TIPS Sale agreement/contract between Vendor and a TIPS Member, that clause may not require that the arbitration is mandatory or binding. Vendor agrees that if any "Arbitration" provision is included in any TIPS Sale agreement/contract between Vendor and a TIPS Member, that clause provides for only voluntary and non-binding arbitration unless the TIPS Member expressly agrees otherwise. Any TIPS Sale Supplemental Agreement containing a "Arbitration" clause that conflicts with these terms is rendered void and unenforceable.

In Witness Whereof, the parties hereto, each acting under due and proper authority, have signed this Agreement.

TIPS VENDOR AGREEMENT SIGNATURE FORM

TIPS RFP 240504 Shelters for Storm, Active Shooter, and other Emergencies (2 Part with JOC) – Part 1

Vendor Name: Sunsafe Film LLC

Vendor Address: 11703 Huebner Road STE 106-401

City: San Antonio State: TX Zip Code: 78230

Vendor Authorized Signatory Name: Bryan Sleger

Vendor Authorized Signatory Title: Director of Sales

Vendor Authorized Signatory Phone: 210-488-4275

Vendor Authorized Signatory Email: bryan@sunsafefilm.com

Vendor Authorized Signature:  Date: 06/11/24

(The following is for TIPS completion only)

TIPS Authorized Signatory Name: Dr. David Fitts

TIPS Authorized Signatory Title: Executive Director

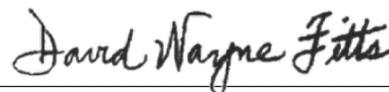
TIPS Authorized Signature:  Date: 9/6/2024



240504

**SunSafe Window Film
SunSafe Window Film
Supplier Response**

Event Information

Number: 240504
Title: Shelters for Storm, Active Shooter, and other Emergencies (2 Part with JOC)
Type: Request for Proposal
Issue Date: 5/2/2024
Deadline: 6/21/2024 03:00 PM (CT)
Notes: This is a solicitation issued by The Interlocal Purchasing System (TIPS), a department of Texas Region 8 Education Service Center. It is an Indefinite Delivery, Indefinite Quantity ("IDIQ") solicitation. It will result in contracts that provide, through adoption/"piggyback" an indefinite quantity of supplies/services, during a fixed period of time, to TIPS public entity and qualifying non-profit "TIPS Members" throughout the nation. Thus, there is no specific project or scope of work to review. Rather this solicitation is issued as a prospective award for utilization when any TIPS Member needs the goods or services offered during the life of the agreement.

This is a two part solicitation. Part 1 is solicited for TIPS sales that are not considered a "public work" construction project. Part 1 permits the sale of goods and non-construction/non-"public work" services such as maintenance and minor repairs. Part 2 Job Order Contract (JOC) is solicited for projects considered by your TIPS Member Customers to be a "public work" construction project. The determination of whether or not a TIPS sale amounts to a "public work" construction project requiring a Part 2 JOC

contract is made by the TIPS Member Customer at the time of each TIPS sale. Thus, Vendors are encouraged to respond to both Parts 1 and 2 in case your TIPS Member Customers require that a sale be made under one Part or the other. However, responding to both Parts is not required.

IF YOU CURRENTLY HOLDS TIPS CONTRACT 210504 SHELTERS FOR STORM, ACTIVE SHOOTER AND OTHER EMERGENCIES, YOU MUST RESPOND TO THIS SOLICITATION TO PREVENT LAPSE OF CONTRACT UNLESS YOU HOLD ANOTHER CURRENT TIPS CONTRACT THAT COVERS ALL OF YOUR SHELTER OFFERINGS. THIS AWARDED CONTRACT WILL REPLACE YOUR EXPIRING TIPS CONTRACT 210504 SHELTERS FOR STORM, ACTIVE SHOOTER AND OTHER EMERGENCIES.

IF YOU HOLD ANOTHER TIPS CONTRACT OTHER THAN 210504 WHICH COVERS ALL OF YOUR SHELTER OFFERINGS AND YOU ARE SATISFIED WITH IT, THERE IS NO NEED TO RESPOND TO THIS SOLICITATION UNLESS YOU PREFER TO HOLD BOTH CONTRACTS.

Contact Information

Address: Region 8 Education Service Center
4845 US Highway 271 North
Pittsburg, TX 75686
Phone: +1 (866) 839-8477
Email: bids@tips-usa.com

SunSafe Window Film Information

Contact: Bryan Sleger
Address: 11703 Huebner Rd Ste 106-401
San Antonio, TX 78230
Phone: (210) 393-5088
Email: bryan@sunsafefilm.com
Web Address: sunsafefilm.com

By submitting your response, you certify that you are authorized to represent and bind your company.

Bryan Sleger
Signature

bryan@sunsafefilm.com
Email

Submitted at 6/20/2024 09:22:57 AM (CT)

Requested Attachments

Pricing Form 1 (Part 1)

240504 Pricing Form 1 (Part 1)TIPS.xlsx

If responding to Part 1, Pricing Form 1 (Part 1) must be downloaded from the "Attachments" section of the IonWave eBid System, reviewed, properly completed as instructed, and uploaded to this location.

Pricing Form 2 (Part 1)

240504 Pricing Form 2 (Part 1)TIPS.xlsx

If responding to Part 1, Pricing Form 2 (Part 1) must be downloaded from the "Attachments" section of the IonWave eBid System, reviewed, properly completed as instructed, and uploaded to this location.

Vendor Agreement (Part 1)

240504 Vendor Agreement (Part 1)TIPS.pdf

If responding to Part 1, the Vendor Agreement must be downloaded from the "Attachments" section of the IonWave eBid System, reviewed, Vendor Name placed in the line provided at the top, and uploaded to this location. If Vendor has proposed deviations to the Vendor Agreement (Part 1), Vendor may assert so in the Attribute Questions and those shall be addressed during evaluation.

Alternate or Supplemental Pricing Documents (Part 1)

No response

Optional. If responding to Part 1, when completing Pricing Form 1 (Part 1) & Pricing Form 2 (Part 1), you direct TIPS to view additional, alternate, or supplemental pricing documentation, you may upload that Part 1 documentation.

Vendor Agreement Signature Form (Part 1)

240504 Vendor Agreement Signature Form (Part 1)TIPS.pdf

If responding to Part 1 the Vendor Agreement Signature Form (Part 1) must be downloaded from the "Attachments" section of the IonWave eBid System, reviewed, properly completed, and uploaded to this location. If Vendor has proposed deviations to the Vendor Agreement (Part 1), Vendor may leave the signature line of this page blank and assert so in the Attribute Questions and those shall be addressed during evaluation.

Current Form W-9

Sunsafe Film LLC W9_2024.pdf

Vendor must upload their current IRS Tax Form W-9. The legal name, EIN, and d/b/a's listed should match the information provided herein exactly. This form will be utilized by TIPS to properly identify your entity.

Required Confidentiality Claim Form

240504 Required Confidentiality Claim Form.pdf

The Required Confidentiality Claim Form must be downloaded from the "Attachments" section of the IonWave eBid System, reviewed, properly completed, and uploaded to this location. This is the only way for Vendor to assert confidentiality of any information submitted.

Reference Form

240504 Reference Form JOC
(Parts 1 & 2) (1)TIPS.xls

The Reference Form must be downloaded from the "Attachments" section of the IonWave eBid System, reviewed, properly completed, and uploaded to this location. The Reference Form must be uploaded in Excel format.

Part 2 Required Bonding Capacity Letter

No response

If proposing on Part 2, Vendor is required to upload a Bonding Capacity Letter from its surety, as described herein, at this location. Please see the attachment entitled "Instructions and Sample - Part 2 Required Bonding Capacity Letter" for complete instructions. . On Part 2, Vendor will be scored on the aggregate bonding capacity displayed in the accepted letter. Vendor must provide a current letter (issued on or after the first day of the month preceding the date on which the solicitation was posted) from its surety verifying Vendor's bonding capacity as described herein. (Ex. if the solicitation/bid posted on February 4, 2022, the letter must be dated on or after January 1 2022. The letter must be issued from Vendor's Surety companies, on surety company letterhead, must specify the maximum bonding capacity of the Vendor, and must be signed by an authorized representative of the surety company. The issuing surety must be authorized to do business in the State of Texas and must be listed on the Department of the Treasury's Listing of Approved Sureties (Department Circular 570).

Vendor Agreement (Part 2)

240504 Vendor Agreement - JOC
(Part 2)TIPS.pdf

If responding to Part 2, the Vendor Agreement (Part 2) must be downloaded from the "Attachments" section of the IonWave eBid System, reviewed, properly completed, and uploaded to this location. If Vendor has proposed deviations to the Vendor Agreement (Part 2), Vendor may assert so in the Attribute Questions and those shall be addressed during evaluation.

Vendor Agreement Signature Form (Part 2)

240504 Vendor Agreement
Signature Form (Part 2)TIPS.pdf

If responding to Part 2, the Vendor Agreement Signature Form (Part 2) must be downloaded from the "Attachments" section of the IonWave eBid System, reviewed, properly completed, and uploaded to this location. If Vendor has proposed deviations to the Vendor Agreement (Part 2), Vendor may leave the signature line of this page blank and assert so in the Attribute Questions and those shall be addressed during evaluation.

Certificates & Licenses (Supplemental Vendor Information Only)

No response

Optional. If Vendor would like to display any applicable certificates or licenses (including HUB certificates) for TIPS and TIPS Member Customer consideration, Vendor may upload those at this location. These supplemental documents shall not be considered part of the TIPS Contract. Rather, they are Vendor Supplemental Information for marketing and informational purposes only.

Vendor's Warranties, Terms, and Conditions (Supplemental Vendor Information Only)

Sunsafe Film Warranty-3M
films.docx

Optional. If Vendor would like to display any standard warranties, terms, or conditions which are often applicable to their offerings for TIPS and TIPS Member Customer consideration, Vendor may upload those at this location. These supplemental documents shall not be considered part of the TIPS Contract. Rather, they are Vendor Supplemental Information for marketing and informational purposes only.

Supplemental Vendor Information (Supplemental Vendor Information Only)

Riotglass Brochure.pdf

Optional. If Vendor would like to display or include any brochures, promotional documents, marketing materials, or other Vendor Information for TIPS and TIPS Member Customer consideration, Vendor may upload those at this location. These supplemental documents shall not be considered part of the TIPS Contract. Rather, they are Vendor Supplemental Information for marketing and informational purposes only.

Disclosure of Lobbying Activities - Standard Form - LLL

No response

Do not upload this form unless Vendor has reportable lobbying activities. There are Attributes entitled, "2 CFR Part 200 or Federal Provision - Byrd Anti-Lobbying Amendment – Continued." Properly respond to those Attributes and only upload this form if applicable/instructed. If upload is required based on your response to those Attributes, the Disclosure of Lobbying Activities – Standard Form - LLL must be downloaded from the "Attachments" section of the IonWave eBid System, reviewed, properly completed, and uploaded to this location.

Conflict of Interest Questionnaire - Form CIQ

No response

Do not upload this form unless you have a reportable conflict with TIPS. There is an Attribute entitled "Conflict of Interest Questionnaire Requirement" immediately followed by an Attribute entitled "Conflict of Interest Questionnaire Requirement – Form CIQ – Continued." Properly respond to those Attributes and only upload this form if applicable/instructed. If upload is required based on your response to those Attributes, the Conflict of Interest Questionnaire – Form CIQ must be downloaded from the "Attachments" section of the IonWave eBid System, reviewed, properly completed, and uploaded at this location.

Vendor Logo (Supplemental Vendor Information Only)

sunsafelogo.jpg

Optional. If Vendor desires that their logo be displayed on their public TIPS profile for TIPS and TIPS Member viewing, Vendor may upload that logo at this location. These supplemental documents shall not be considered part of the TIPS Contract. Rather, they are Vendor Supplemental Information for marketing and informational purposes only.

Bid Attributes

1	Disadvantaged/Minority/Women Business & Federal HUBZone Some participating public entities are required to seek Disadvantaged/Minority/Women Business & Federal HUBZone ("D/M/WBE/Federal HUBZone") vendors. Does Vendor certify that their entity is a D/M/WBE/Federal HUBZone vendor? If you respond "Yes," you must upload current certification proof in the appropriate "Response Attachments" location. <input type="text" value="NO"/>
2	Historically Underutilized Business (HUB) Some participating public entities are required to seek Historically Underutilized Business (HUB) vendors as defined by the Texas Comptroller of Public Accounts Statewide HUB Program. Does Vendor certify that their entity is a HUB vendor? If you respond "Yes," you must upload current certification proof in the appropriate "Response Attachments" location. <input type="text" value="No"/>
3	National Coverage Can the Vendor provide its proposed goods and services to all 50 US States? <input type="text" value="Yes - All 50 States"/>
4	States Served If Vendor answered "No" to the question entitled "National Coverage," please list all states where vendor can provide the goods and services proposed directly below. Your response may dictate which potential TIPS Member customers consider purchasing your offerings. <input type="text" value="N/A"/>
5	Description of Vendor Entity and Vendor's Goods & Services If awarded, this description of Vendor and Vendor's goods and services will appear on the TIPS website for customer/public viewing. <input type="text" value="Provides and installs forced entry and bullet-resistant glazing solutions for buildings and vehicles such as UL-752 Levels 1-7 bullet-resistant glass, ballistic security films, bullet-resistant storefront, security fencing, and active shooter solutions/shelters."/>

6	Primary Contact Name Please identify the individual who will be primarily responsible for all TIPS matters and inquiries for the duration of the contract. <input type="text" value="Bryan Sleger"/>
----------	---

7	Primary Contact Title Primary Contact Title <input type="text" value="Director of Sales"/>
----------	---

8	Primary Contact Email Please enter a valid email address that will definitely reach the Primary Contact. <input type="text" value="bryan@sunsafefilm.com"/>
----------	--

9	Primary Contact Phone Numbers only, no symbols or spaces (Ex. 8668398477). The system will auto-populate your entry with commas once submitted which is appropriate and expected (Ex. 8,668,398,477). Please provide the accurate and current phone number where the individual who will be primarily responsible for all TIPS matters and inquiries for the duration of the contract can be reached directly. <input type="text" value="2104884275"/>
----------	--

10	Primary Contact Fax Numbers only, no symbols or spaces (Ex. 8668398477). The system will auto-populate your entry with commas once submitted which is appropriate and expected (Ex. 8,668,398,477). <input type="text" value="No response"/>
-----------	---

11	Primary Contact Mobile Numbers only, no symbols or spaces (Ex. 8668398477). The system will auto-populate your entry with commas once submitted which is appropriate and expected (Ex. 8,668,398,477). <input type="text" value="2104884275"/>
-----------	---

12	Secondary Contact Name Please identify the individual who will be secondarily responsible for all TIPS matters and inquiries for the duration of the contract. <input type="text" value="Daniel Aguilar"/>
-----------	---

13	Secondary Contact Title Secondary Contact Title <input type="text" value="General Manager"/>
-----------	---

14	Secondary Contact Email Please enter a valid email address that will definitely reach the Secondary Contact. <input type="text" value="sales@sunsafefilm.com"/>
-----------	--

1 5	Secondary Contact Phone Numbers only, no symbols or spaces (Ex. 8668398477). The system will auto-populate your entry with commas once submitted which is appropriate and expected (Ex. 8,668,398,477). Please provide the accurate and current phone number where the individual who will be secondarily responsible for all TIPS matters and inquiries for the duration of the contract can be reached directly. <input type="text" value="2104546280"/>
--------	--

1 6	Secondary Contact Fax Numbers only, no symbols or spaces (Ex. 8668398477). The system will auto-populate your entry with commas once submitted which is appropriate and expected (Ex. 8,668,398,477). <input type="text" value="No response"/>
--------	---

1 7	Secondary Contact Mobile Numbers only, no symbols or spaces (Ex. 8668398477). The system will auto-populate your entry with commas once submitted which is appropriate and expected (Ex. 8,668,398,477). <input type="text" value="2104546280"/>
--------	---

1 8	Administration Fee Contact Name Please identify the individual who will be responsible for all payment, accounting, and other matters related to Vendor's TIPS Administration Fee due to TIPS for the duration of the contract. <input type="text" value="Bryan Sleger"/>
--------	--

1 9	Administration Fee Contact Email Please enter a valid email address that will definitely reach the Administration Fee Contact. <input type="text" value="bryan@sunsafefilm.com"/>
--------	--

2 0	Administration Fee Contact Phone Numbers only, no symbols or spaces (Ex. 8668398477). The system will auto-populate your entry with commas once submitted which is appropriate and expected (Ex. 8,668,398,477). <input type="text" value="2104884275"/>
--------	---

2 1	Purchase Order and Sales Contact Name Please identify the individual who will be responsible for receiving and processing purchase orders and sales under the TIPS Contract. <input type="text" value="Bryan Sleger"/>
--------	---

2 2	Purchase Order and Sales Contact Email Please enter a valid email address that will definitely reach the Purchase Order and Sales Contact. <input type="text" value="bryan@sunsafefilm.com"/>
--------	--

2 3	Purchase Order and Sales Contact Phone Numbers only, no symbols or spaces (Ex. 8668398477). The system will auto-populate your entry with commas once submitted which is appropriate and expected (Ex. 8,668,398,477). <input type="text" value="2104884275"/>
--------	---

2 4	Company Website Company Website (Format - www.company.com) <input type="text" value="www.sunsafefilm.com"/>
--------	--

2
5

Entity D/B/A's and Assumed Names

You must confirm that you are responding to this solicitation under your legal entity name. Go now to your Supplier Profile in this eBid System and confirm that your profile reflects your "Legal Name" as it is listed on your W9.

In this question, please identify all of your entity's assumed names and D/B/A's. Please note that you will be identified publicly by the Legal Name under which you respond to this solicitation unless you organize otherwise with TIPS after award.

Sunsafe, Sunsafe Film

2
6

Primary Address

Primary Address

11701 Huebner Road STE 106-401

2
7

Primary Address City

Primary Address City

San Antonio

2
8

Primary Address State

Primary Address State (2 Digit Abbreviation)

Texas

2
9

Primary Address Zip

Primary Address Zip

78230

3
0

Search Words Identifying Vendor

Please list all search words and phrases to be included in the TIPS database related to your entity. **Do not** list words which are not associated with the bid category/scope (See bid title for general scope). This will help users find you through the TIPS website search function. You may include product names, manufacturers, specialized services, and other words associated with the scope of this solicitation.

security, film, glass, bullet-resistant, ballistic, solar, fencing, framing, storefront, forced entry, resistant, safety film, security film, solar film, glazing, bullet-resistant glass, active shooter, storm

3
1

Certification of Vendor Residency (Required by the State of Texas)

Does Vendor's parent company or majority owner:

(A) have its principal place of business in Texas; **or** (B) employ at least 500 persons in Texas?

Texas Education Code Section 44.031 requires that this information be considered in evaluation for certain contracts. However, Vendor response does not affect points, scoring, or potential award.

Yes

3
2

Vendor's Principal Place of Business (City)

In what city is Vendor's principal place of business located?

San Antonio

3 3	Vendor's Principal Place of Business (State) In what state is Vendor's principal place of business located? <input type="text" value="Texas"/>
----------------------	---

3 4	Vendor's Years in Business How many years has the business submitting this proposal been operating in its current capacity and field of work? <input type="text" value="28"/>
----------------------	--

3 5	Certification Regarding Entire TIPS Agreement for Part 1 and Part 2 Contracts <p>This is a two part solicitation. Part 1 is solicited for TIPS sales that are not considered a "public work" construction project. Part 1 permits the sale of goods and non-construction/non-"public work" services such as maintenance and minor repairs. Part 2 Job Order Contract (JOC) is solicited for projects considered by your TIPS Member Customers to be a "public work" construction project. The determination of whether or not a TIPS sale amounts to a "public work" construction project requiring a Part 2 JOC contract is made by the TIPS Member Customer at the time of each TIPS sale. Thus, Vendors are encouraged to respond to both Parts 1 and 2 in case your TIPS Member Customers require that a sale be made under one Part or the other. However, responding to both Parts is not required. If Vendor responds and is awarded to both Parts, Vendor will have one contract for Part 1 and a separate contract for Part 2.</p> <p>Vendor agrees that, if awarded, Vendor's final TIPS Contract(s), for either Part 1, Part 2, or both Parts, will consist of the provisions set forth in the corresponding finalized TIPS Vendor Agreement, Vendor's responses to these attribute questions, and: (1) The TIPS solicitation document resulting in the Agreement; (2) Any addenda or clarifications issued in relation to the corresponding TIPS solicitation; (3) All solicitation information provided to Vendor by TIPS through the TIPS eBid System; (3) Vendor's entire proposal response to the corresponding TIPS solicitation including all accepted required attachments, acknowledged notices and certifications, accepted negotiated terms, accepted pricing, accepted responses to questions, and accepted written clarifications of Vendor's proposal, and; any properly included attachments to the TIPS Contract.</p> <p>Does Vendor agree? <input type="text" value="Yes, Vendor agrees"/></p>
----------------------	--

**3
6** Minimum Percentage Discount Offered to TIPS Members on all Part 1 Goods and Services (READ CAREFULLY)

Please read thoroughly and carefully as an error on your response can render your Part 1 contract award unusable. If you are not proposing on Part 1, you must still respond to proceed but it will not apply to you unless you decide to propose and are awarded on Part 1.

TIPS Members often turn to TIPS Contracts for ease of use and to receive discounted pricing.

If awarded on Part 1, what is the minimum percentage discount that you can offer TIPS Members off of all Part 1 goods and service pricing (whether offered through Pricing Form 1, Pricing Form 2, or in another accepted format) that you offer? Only limited goods/services specifically identified and excluded from this discount in Vendor's original proposal may be excluded from this discount.

Vendor must respond with a percentage from 0%-100%. The percentage discount that you input below will be applied to your Part 1 "Catalog Pricing", as defined in the solicitation, for all TIPS Sales made during the life of the contract. You cannot alter this percentage discount once the solicitation legally closes. You will always be required to discount every TIPS Sale by the percentage included below with the exception of limited goods/services specifically identified and excluded from this discount in Vendor's original proposal. If you add goods or services to your "Catalog Pricing" during the life of the contract, you will be required to sell those new items with this discount applied.

Example: In this example, you enter a 10% minimum percentage discount below. In year-one of your TIPS Contract, your published Part 1 "Catalog Pricing" (website/store/published pricing) for "Material A" is \$100 and for "Material A Maintenance Service" is \$100. In this example, you must sell those items under the Part 1 TIPS Contract at the proposed 10% discounted price of: "Material A" - \$90, "Material A Maintenance Service" - \$90. In year two of your TIPS Contract, you update your Part 1 "Catalog Pricing" with the market. You add "Material B" to your "Catalog Pricing" for \$200 and have increased the price of "Material A" to \$110 and the price of "Material A Maintenance Service" to \$110. In this example, after the Part 1 "Catalog Pricing" update, you must still sell those items under the Part 1 TIPS Contract at the proposed 10% discounted price of: "Material A" - \$99, "Material A Maintenance Service" - \$99, and "Material B" - \$180.00.

With the exception of limited goods/services specifically identified and excluded from this discount in Vendor's original proposal, if you cannot honor the discount on all Part 1 goods and items now included or which may be added in the future with certainty, then you should offer a lesser discount percentage below.

If awarded on Part 1, what is the minimum percentage discount that you can offer TIPS Members off of all Part 1 goods and service pricing (whether offered through Pricing Form 1, Pricing Form 2, or in another accepted format) that you offer?

**3
7** Honoring Vendor's Part 1 Minimum Percentage Discount

Vendor is asked in these Attribute Questions to provide a Minimum Percentage Discount offered to TIPS Members on all Part 1 goods and services sold under the TIPS Contract. If proposing on Part 1, points will be assigned for your response and scoring of your Part 1 proposal will be affected. On your Part 1 evaluation, a "YES" answer will be awarded the maximum 10 points and a "NO" answer will be awarded 0 points. If you are not proposing on Part 1, you must still answer to proceed but this term will not apply to you or affect your scoring unless you decide to propose and are awarded on Part 1.

If awarded on Part 1, does Vendor agree to honor the Minimum Percentage Discount off of their TIPS "Catalog Pricing" that Vendor proposed for all TIPS Sales made for the duration of the TIPS Contract?

3
8 **Volume and Additional Discounts**

In addition to the Part 1 Minimum Percentage Discount proposed herein, does Vendor ever expect and intend to offer additional, greater, or volume discounts to TIPS Members?

If proposing on Part 1, point(s) may be assigned for your response in the Part 1 category of "Pricing" during scoring and evaluation. If you are not proposing on Part 1, you must respond to proceed but no points will be assigned for your response.

3
9 **Part 1 "Catalog Pricing" and Pricing Requirements**

This is a requirement of the Part 1 TIPS Contract and is non-negotiable. If you are not proposing on Part 1, you must still agree to proceed but it will not apply to you unless you decide to propose and are awarded on Part 1.

In this solicitation and resulting contract, Part 1 "Catalog Pricing" shall be defined as:

"The then available list of goods or services, in the most current listing regardless of date, that takes the form of a catalog, price list, price schedule, shelf-price or other viewable format that:

- A. is regularly maintained by the manufacturer or Vendor of an item; and
- B. is either published or otherwise available for review by TIPS or a customer during the purchase process;
- C. to which the Minimum Percentage Discount proposed by the proposing Vendor may be applied.

If awarded on Part 1 of this TIPS Contract, for the duration of the contract, Vendor agrees to provide, upon request, their then current "Catalog Pricing." Or, in limited circumstances where Vendor has proposed the Percentage Mark-Up method of pricing in this proposal, proof of Vendor's "cost" may be accepted by TIPS in place of catalog pricing.

4
0 **REQUIRED FOR PART 2 - Vendor's Regular Hours RS Means Coefficient**

What is Vendor's Regular Hours RS Means Coefficient? **If you do not intend to propose on Part 2, you may enter a "0" in order to continue.**

The RS Means Price Book is a unit price book adjusted for different geographic areas by using the City Cost Index for each location. You may visit <https://www.rsmeans.com> for more information.

You must review the TIPS Part 2 RS Means JOC Pricing Explanation & Rubric under the "Attachments" tab prior to responding herein.

To propose the RS Means Price Book pricing exactly, Vendor would insert a 1.0 as their Regular Hours RS Means Coefficient below, to propose a 5% discount off of the RS Means Price Book Vendor would insert a .95 as their Regular Hours RS Means Coefficient below. To see the full scoring rubric and use TIPS scoring calculator, please view the TIPS RS Means JOC Pricing Explanation & Rubric under the "Attachments" tab.

Insert Vendor's Regular Hours RS Means Coefficient below. **If you do not intend to propose on Part 2, you may enter a "0" in order to continue.**

4 **REQUIRED FOR PART 2 - Vendor's After-Hours RS Means Coefficient**

1

What is Vendor's After-Hours RS Means Coefficient? **If you do not intend to propose on Part 2, you may enter a "0" in order to continue.**

The RS Means Price Book is a unit price book adjusted for different geographic areas by using the City Cost Index for each location. You may visit <https://www.rsmeans.com> for more information.

You must review the TIPS Part 2 RS Means JOC Pricing Explanation & Rubric under the "Attachments" tab prior to responding herein.

The most common After-Hours RS Means Coefficient is "time-and-a-half" of the standard RS Means Unit Price Book. For example, if Vendor's Regular Hours Coefficient above is .95, Vendor would assert an After-Hours RS Means Coefficient of 1.45 for "time-and-a-half" pricing. To see the full scoring rubric and use TIPS scoring calculator, please view the TIPS RS Means JOC Pricing Explanation & Rubric under the "Attachments" tab.

Insert Vendor's After-Hours RS Means Coefficient below. **If you do not intend to propose on Part 2, you may enter a "0" in order to continue.**

4 **REQUIRED FOR PART 2 - Vendor's Percentage Markup of Items not Pre-Priced within the RS Means Price Book**

2

Here, Vendor must enter a percentage, not a coefficient. **If you do not intend to propose on Part 2, you may enter a "0" in order to continue.**

If Vendor sells items which cannot be found in the RS Means Price Book, at what Percentage Markup does Vendor agree to sell those Non Pre-Priced items? This is a maximum Percentage Markup and Vendor may always offer customers a lesser markup.

Example: In this example, Vendor is selling a project to a TIPS Member school district and some of the contract pricing for special materials cannot be verified because it cannot be found in the RS Means Price book. Vendor may sell those specialty items to the Member this percentage markup from cost. In this example, if one of the specialty items cost Vendor \$100 from the manufacturer and Vendor proposed a Percentage Markup of 30% here, then Vendor could sell the item to the TIPS Customer for \$130.00 or less in this example.

Vendor must provide TIPS with manufacturer documentation reflecting the cost of any non pre-priced item at the time of the TIPS sale so that TIPS can verify that the proposed percentage markup is being honored.

What is Vendor's Percentage Markup of items not Pre-Priced within the RS Means Price Book? **If you do not intend to propose on Part 2, you may enter a "0" in order to continue.**

4
3

REQUIRED FOR PART 2 - TIPS Pricing and Line Item Estimate Pricing Requirements

This is a requirement of the Part 2 TIPS Contract and is non-negotiable. If you are not proposing on Part 2, you must still agree to proceed but it will not apply to you unless you decide to propose and are awarded on Part 2.

Vendor must respond to the required pricing attributes above seeking RS Means coefficients and a percentage markup if seeking to propose on Part 2.

If awarded on Part 2 of this TIPS Contract, for the duration of the contract, Vendor agrees to provide a RS Means line-item estimate to TIPS for each anticipated Part 2 TIPS project or sale. Or, in limited circumstances in contracts where Xactimate pricing is also expressly permitted and Vendor also submits Xactimate pricing under Part 2, Vendor may instead provide an Xactimate line-item estimate to TIPS. However, Vendor agrees that when a TIPS Member Customer seeks a quote for a Part 2 TIPS sale, Vendor will always supply a line-item estimate to TIPS for review and approval.

4
4

EXCEPTIONS & DEVIATIONS TO TIPS STANDARD TERMS AND CONDITIONS

Vendor agrees that, if awarded, Vendor's final TIPS Part 1 and/or Part 2 Contract will consist of the provisions set forth in the finalized TIPS Vendor Agreement, Vendor's responses to these attribute questions, and: (1) The corresponding TIPS solicitation document resulting in this Agreement; (2) Any addenda or clarifications issued in relation to the corresponding TIPS solicitation; (3) All solicitation information provided to Vendor by TIPS through the TIPS eBid System; (3) Vendor's entire proposal response to the corresponding TIPS solicitation including all accepted required attachments, acknowledged notices and certifications, accepted negotiated terms, accepted pricing, accepted responses to questions, and accepted written clarifications of Vendor's proposal, and; any properly included attachments to the TIPS Contract. In the event of conflict between the terms of the finalized Vendor Agreement and one of the incorporated documents the terms and conditions which are in the best interest of governmental/qualifying non-profit TIPS Members shall control at TIPS sole discretion.

If Vendor responds, "No, Vendor does not agree" to this Attribute, after this solicitation legally closes and TIPS begins evaluating Vendor's file, TIPS will provide Vendor with a draft Word Document version of the Vendor Agreement and will be instructed to include all requested negotiations as redline edits for TIPS consideration. This is the only proper way to submit proposed deviations for TIPS consideration. TIPS reserves the right to accept, decline, or modify Vendor's requested negotiated terms. For this reason, answering "No, Vendor does not agree" may ultimately delay or prevent award.

Does Vendor agree with TIPS standard terms and conditions as presented in the TIPS solicitation document (RFP, RCSP, RFQ, or other) and the TIPS Vendor Agreement document?

4 **TIPS Sales Reporting Requirements**

5 **This is a requirement of the TIPS Contract and is non-negotiable.**

By submitting this proposal, Vendor certifies that Vendor will properly report all TIPS sales. With the exception of TIPS Automated Vendors, who have signed an exclusive agreement with TIPS regarding reporting, all TIPS Sales must be reported to TIPS by either:

(1) Emailing the purchase order or similar purchase document (with Vendor's Name, as known to TIPS, and the TIPS Contract Name and Number included) to TIPS at tipspo@tips-usa.com with "Confirmation Only" in the subject line of the email within three business days of Vendor's acceptance of the order, or;

(2) Within 3 business days of the order being accepted by Vendor, Vendor must login to the TIPS Vendor Portal and successfully self-report all necessary sale information within the Vendor Portal and confirm that it shows up accurately on your current Vendor Portal statement.

No other method of reporting is acceptable unless agreed to by the Parties in writing. Failure to report all sales pursuant to this provision may result in immediate cancellation of Vendor's TIPS Contract(s) for cause at TIPS' sole discretion.

4 **TIPS Administration Fee Requirement and Acknowledgment**

6 **This is a requirement of the TIPS Contract and is non-negotiable.**

The collection of fees by TIPS, a government entity, for performance of these procurement services is required pursuant to Texas Government Code Section 791.011 et. seq. The TIPS Administration Fee is the amount legally owed by Vendor to TIPS for TIPS Sales made by Vendor. The TIPS Administration Fee amount is typically a set percentage of each TIPS Sale legally due to TIPS, but the exact TIPS Administration Fee for this Contract is published in the corresponding RFP or RCSP document. TIPS Administration Fees are due to TIPS immediately upon Vendor's receipt of payment, including partial payment, for a TIPS Sale.

By submitting a proposal, Vendor agrees that it has read, understands, and agrees to the published TIPS Administration Fee amount, calculation, and payment requirements. By submitting a proposal Vendor further confirms that all TIPS Pricing includes the TIPS Administration Fee and Vendor will not show adding the TIPS Administration Fee as a charge or line-item in any TIPS Sale.

4 **TIPS Member Access to Vendor Proposal & Documentation**

7 **This is a requirement of the TIPS Contract and is non-negotiable.**

Notwithstanding any other information provided in this solicitation or Vendor designation of certain documentation as confidential or proprietary, Vendor's submission of this proposal constitutes Vendor's express consent to the disclosure of Vendor's comprehensive proposal, including any information deemed confidential or proprietary, **to TIPS Members**. The proposing Vendor agrees that TIPS shall not be responsible or liable for any use or distribution of information or documentation to TIPS Members or by TIPS Members. By submitting this proposal, Vendor certifies the foregoing.

4
8

Non-Collusive Bidding Certificate

This is a requirement of the TIPS Contract and is non-negotiable.

By submission of this proposal, the Vendor certifies that:

- 1) This proposal has been independently arrived at without collusion with any other entity, bidder, or with any competitor;
- 2) This proposal has not been knowingly disclosed and will not be knowingly disclosed, prior to the opening of bids, or proposals for this project, to any other bidder, competitor or potential competitor;
- 3) No attempt has been or will be made to induce any other person, partnership or corporation to modify, submit, or not to submit a bid or proposal; and
- 4) The person signing this bid or proposal certifies that they are duly authorized to execute this proposal/contract on behalf of Vendor and they have fully informed themselves regarding the accuracy of the statements contained in this certification, and under the penalties being applicable to the bidder as well as to the person signing in its behalf;

4
9

Antitrust Certification Statements (Tex. Government Code § 2155.005)

This is a requirement of the TIPS Contract and is non-negotiable.

By submission of this bid or proposal, Vendor certifies under penalty of perjury of the laws of the State of Texas that:

- (1) I am duly authorized to execute this proposal/contract on my own behalf or on behalf of the company, corporation, firm, partnership or individual (Vendor) identified herein;
- (2) In connection with this proposal, neither I nor any representative of Vendor has violated any provision of the Texas Free Enterprise and Antitrust Act, Tex. Bus. & Comm. Code Chapter 15;
- (3) In connection with this proposal, neither I nor any representative of the Vendor has violated any federal antitrust law;
- (4) Neither I nor any representative of Vendor has directly or indirectly communicated any of the contents of this bid to a competitor of the Company or any other company, corporation, firm, partnership or individual engaged in the same line of business as the Company.

5
0

Limitation on Out-of-State Litigation - Texas Business and Commerce Code § 272

This is a requirement of the TIPS Contract and is non-negotiable.

Texas Business and Commerce Code § 272 prohibits a construction contract, or an agreement collateral to or affecting the construction contract, from containing a provision making the contract or agreement, or any conflict arising under the contract or agreement, subject to another state's law, litigation in the courts of another state, or arbitration in another state. If included in Texas construction contracts, such provisions are voidable by a party obligated by the contract or agreement to perform the work.

By submission of this proposal, Vendor acknowledges this law and ***if Vendor enters into a construction contract with a Texas TIPS Member*** under this procurement, Vendor certifies compliance.

5
1

Required Confidentiality Claim Form

This is a requirement of the TIPS Contract and is non-negotiable.

TIPS provides the required TIPS Confidentiality Claim Form in the "Attachments" section of this solicitation. Vendor must execute this form by either signing and waiving any confidentiality claim, or designating portions of Vendor's proposal confidential. If Vendor considers any portion of Vendor's proposal to be confidential and not subject to public disclosure pursuant to Chapter 552 Texas Gov't Code or other law(s) and orders, Vendor must have identified the claimed confidential materials through proper execution of the Confidentiality Claim Form.

If TIPS receives a public information act or similar request, any responsive documentation not deemed confidential by you in this manner will be automatically released. For Vendor documents deemed confidential by you in this manner, TIPS will follow procedures of controlling statute(s) regarding any claim of confidentiality and shall not be liable for any release of information required by law, including Attorney General determination and opinion.

Notwithstanding any other Vendor designation of Vendor's proposal as confidential or proprietary, Vendor's submission of this proposal constitutes Vendor's agreement that proper execution of the required TIPS Confidentiality Claim Form is the only way to assert any portion of Vendor's proposal as confidential.

5
2

Non-Discrimination Statement and Certification

This is a requirement of the TIPS Contract and is non-negotiable.

In accordance with Federal civil rights law, all U.S. Departments, including but not limited to the USDA, USDE, FEMA, are prohibited from discriminating based on race, color, national origin, religion, sex, gender identity (including gender expression), sexual orientation, disability, age, marital status, family/parental status, income derived from a public assistance program, political beliefs, or reprisal or retaliation for prior civil rights activity, in any program or activity conducted or funded by federal funds (not all bases apply to all programs).

Vendor certifies that Vendor will comply with applicable Non-Discrimination and Equal Opportunity provisions set forth in TIPS Member Customers' policies and other regulations at the local, state, and federal levels of governments.

Yes, I certify

5
3

Limitation of Vendor Indemnification and Similar Clauses

This is a requirement of the TIPS Contract and is non-negotiable.

TIPS, a department of Region 8 Education Service Center, a political subdivision, and local government entity of the State of Texas, is prohibited from indemnifying third-parties (pursuant to the Article 3, Section 52 of the Texas Constitution) except as otherwise specifically provided for by law or as ordered by a court of competent jurisdiction. Article 3, Section 52 of the Texas Constitution states that "no debt shall be created by or on behalf of the State ... " and the Texas Attorney General has opined that a contractually imposed obligation of indemnity creates a "debt" in the constitutional sense. Tex. Att'y Gen. Op. No. MW-475 (1982). Thus, contract clauses which require TIPS to indemnify Vendor, pay liquidated damages, pay attorney's fees, waive Vendor's liability, or waive any applicable statute of limitations must be deleted or qualified with "to the extent permitted by the Constitution and Laws of the State of Texas."

Does Vendor agree?

Yes, I Agree

5
4

Alternative Dispute Resolution Limitations

This is a requirement of the TIPS Contract and is non-negotiable.

TIPS, a department of Region 8 Education Service Center, a political subdivision, and local government entity of the State of Texas, does not agree to binding arbitration as a remedy to dispute and no such provision shall be permitted in this Agreement with TIPS. Vendor agrees that any claim arising out of or related to this Agreement, except those specifically and expressly waived or negotiated within this Agreement, may be subject to non-binding mediation at the request of either party to be conducted by a mutually agreed upon mediator as prerequisite to the filing of any lawsuit arising out of or related to this Agreement. Mediation shall be held in either Camp or Titus County, Texas. Agreements reached in mediation will be subject to the approval by the Region 8 ESC's Board of Directors, authorized signature of the Parties if approved by the Board of Directors, and, once approved by the Board of Directors and properly signed, shall thereafter be enforceable as provided by the laws of the State of Texas.

Does Vendor agree?

5
5

No Waiver of TIPS Immunity

This is a requirement of the TIPS Contract and is non-negotiable.

Vendor agrees that nothing in this Agreement shall be construed as a waiver of sovereign or government immunity; nor constitute or be construed as a waiver of any of the privileges, rights, defenses, remedies, or immunities available to Region 8 Education Service Center or its TIPS Department. The failure to enforce, or any delay in the enforcement, of any privileges, rights, defenses, remedies, or immunities available to Region 8 Education Service Center or its TIPS Department under this Agreement or under applicable law shall not constitute a waiver of such privileges, rights, defenses, remedies, or immunities or be considered as a basis for estoppel.

Does Vendor agree?

Yes, Vendor agrees

5
6

Payment Terms and Funding Out Clause

This is a requirement of the TIPS Contract and is non-negotiable.

Vendor agrees that TIPS and TIPS Members shall not be liable for interest or late-payment fees on past-due balances at a rate higher than permitted by the laws or regulations of the jurisdiction of the TIPS Member.

Funding-Out Clause: Vendor agrees to abide by the applicable laws and regulations, including but not limited to Texas Local Government Code § 271.903, or any other statutory or regulatory limitation of the jurisdiction of any TIPS Member, which requires that contracts approved by TIPS or a TIPS Member are subject to the budgeting and appropriation of currently available funds by the entity or its governing body.

Does Vendor agree?

Yes, Vendor agrees

5
7

Certification Regarding Prohibition of Certain Terrorist Organizations (Tex. Gov. Code 2270)

Vendor certifies that Vendor is not a company identified on the Texas Comptroller's list of companies known to have contracts with, or provide supplies or services to, a foreign organization designated as a Foreign Terrorist Organization by the U.S. Secretary of State.

Does Vendor certify?

5
8

Certification Regarding Prohibition of Boycotting Israel (Tex. Gov. Code 2271)

If (a) Vendor is not a sole proprietorship; (b) Vendor has ten (10) or more full-time employees; and (c) this Agreement or any agreement with a TIPS Member under this procurement has value of \$100,000 or more, the following certification shall apply; otherwise, this certification is not required. Vendor certifies, where applicable, that neither the Vendor, nor any affiliate, subsidiary, or parent company of Vendor, if any, boycotts Israel, and Vendor agrees that Vendor and Vendor Companies will not boycott Israel during the term of this Agreement. For purposes of this Agreement, the term "boycott" shall mean and include refusing to deal with, terminating business activities with, or otherwise taking any action that is intended to penalize, inflict economic harm on, or limit commercial relations with Israel, or with a person or entity doing business in Israel or in an Israeli-controlled territory but does not include an action made for ordinary business purposes.

When applicable, does Vendor certify?

Yes, Vendor certifies

5
9

Certification Regarding Prohibition of Contracts with Certain Foreign-Owned Companies (Tex. Gov. Code 2274)

Certain public entities are prohibited from entering into a contract or other agreement relating to critical infrastructure that would grant Vendor direct or remote access to or control of critical infrastructure in this state, excluding access specifically allowed by a customer for product warranty and support purposes.

Vendor certifies that neither it nor its parent company nor any affiliate of Vendor or its parent company, is (1) owned by or the majority of stock or other ownership interest of the company is held or controlled by individuals who are citizens of China, Iran, North Korea, Russia, or a designated country; (2) a company or other entity, including governmental entity, that is owned or controlled by citizens of or is directly controlled by the government of China, Iran, North Korea, Russia, or a designated country; or (3) headquartered in China, Iran, North Korea, Russia, or a designated country.

For purposes of this certification, "critical infrastructure" means "a communication infrastructure system, cybersecurity system, electric grid, hazardous waste treatment system, or water treatment facility." Vendor certifies that Vendor will not grant direct or remote access to or control of critical infrastructure, except for product warranty and support purposes, to prohibited individuals, companies, or entities, including governmental entities, owned, controlled, or headquartered in China, Iran, North Korea, Russia, or a designated country, as determined by the Governor.

When applicable, does Vendor certify?

Yes, Vendor certifies

60 Certification Regarding Prohibition of Discrimination Against Firearm and Ammunition Industries (Tex. Gov. Code 2274)

If (a) Vendor is not a sole proprietorship; (b) Vendor has at least ten (10) full-time employees; and (c) this Agreement or any Supplemental Agreement with certain public entities have a value of at least \$100,000 that is paid wholly or partly from public funds; (d) the Agreement is not excepted under Tex. Gov. Code 2274 and (e) the purchasing public entity has determined that Vendor is not a sole-source provider or the purchasing public entity has not received any bids from a company that is able to provide this written verification, the following certification shall apply; otherwise, this certification is not required.

Vendor certifies that Vendor, or association, corporation, partnership, joint venture, limited partnership, limited liability partnership, or limited liability company, including a wholly owned subsidiary, majority-owned subsidiary parent company, or affiliate of these entities or associations, that exists to make a profit, does not have a practice, policy, guidance, or directive that discriminates against a firearm entity or firearm trade association and will not discriminate during the term of this contract against a firearm entity or firearm trade association.

For purposes of this Agreement, “discriminate against a firearm entity or firearm trade association” shall mean, with respect to the entity or association, to: “(1) refuse to engage in the trade of any goods or services with the entity or association based solely on its status as a firearm entity or firearm trade association; (2) refrain from continuing an existing business relationship with the entity or association based solely on its status as a firearm entity or firearm trade association; or (3) terminate an existing business relationship with the entity or association based solely on its status as a firearm entity or firearm trade association.”

“Discrimination against a firearm entity or firearm trade association” does not include: “(1) the established policies of a merchant, retail seller, or platform that restrict or prohibit the listing or selling of ammunition, firearms, or firearm accessories; and (2) a company’s refusal to engage in the trade of any goods or services, decision to refrain from continuing an existing business relationship, or decision to terminate an existing business relationship to comply with federal, state, or local law, policy, or regulations or a directive by a regulatory agency, or for any traditional business reason that is specific to the customer or potential customer and not based solely on an entity’s or association’s status as a firearm entity or firearm trade association.”

When applicable, does Vendor certify?

Yes, Vendor certifies

61 Certification Regarding Termination of Contract for Non-Compliance (Tex. Gov. Code 552.374)

If Vendor is not a governmental body and (a) this Agreement or any Supplemental Agreement with a public entity has a stated expenditure of at least \$1 million in public funds for the purchase of goods or services by certain public entities; or (b) this Agreement or any Supplemental Agreement results in the expenditure of at least \$1 million in public funds for the purchase of goods or services by certain public entities in their fiscal year, the following certification shall apply; otherwise, this certification is not required.

As required by Tex. Gov. Code 552.374, the following statement is included in the RFP and the Agreement (unless the Agreement is (1) related to the purchase or underwriting of a public security; (2) is or may be used as collateral on a loan; or (3) proceeds from which are used to pay debt service of a public security of loan): “The requirements of Subchapter J, Chapter 552, Government Code, may apply to this solicitation and Agreement and the Vendor agrees that this Agreement and any applicable Supplemental Agreement can be terminated if Vendor knowingly or intentionally fails to comply with a requirement of that subchapter.”

Pursuant to Chapter 552 of the Texas Government Code, Vendor certifies that Vendor shall: (1) preserve all contracting information related to this Agreement as provided by the records retention requirements applicable to TIPS or the purchasing TIPS Member for the duration of the Agreement; (2) promptly provide to TIPS or the purchasing TIPS Member any contracting information related to the Agreement that is in the custody or possession of Vendor on request of TIPS or the purchasing TIPS Member; and (3) on completion of the Agreement, either (a) provide at no cost to TIPS or the purchasing TIPS Member all contracting information related to the Agreement that is in the custody or possession of Vendor, or (b) preserve the contracting information related to the Agreement as provided by the records retention requirements applicable to TIPS or the purchasing TIPS Member.

When applicable, does Vendor certify?

Yes, Vendor certifies

6
2

Certification Regarding Prohibition of Boycotting Certain Energy Companies (Tex. Gov. Code 2274)

If (a) Vendor is not a sole proprietorship; (b) Vendor has ten (10) or more full-time employees; and (c) this Agreement or any Supplemental Agreement with certain public entities has a value of \$100,000 or more that is to be paid wholly or partly from public funds, the following certification shall apply; otherwise, this certification is not required.

Vendor certifies that Vendor, or any wholly owned subsidiary, majority-owned subsidiary, parent company, or affiliate of these entities or business associations, if any, do not boycott energy companies and will not boycott energy companies during the term of the Agreement or any applicable Supplemental Agreement.

For purposes of this certification the term "company" shall mean an organization, association, corporation, partnership, joint venture, limited partnership, limited liability partnership, or limited liability company, that exists to make a profit.

The term "boycott energy company" shall mean "without an ordinary business purpose, refusing to deal with, terminating business activities with, or otherwise taking any action intended to penalize, inflict economic harm on, or limit commercial relations with a company because the company (a) engages in the exploration, production, utilization, transportation, sale, or manufacturing of fossil fuel-based energy and does not commit or pledge to meet environmental standards beyond applicable federal and state law, or (b) does business with a company described by paragraph (a)." (See Tex. Gov. Code 809.001).

When applicable, does Vendor certify?

6
3

Felony Conviction Notice - Texas Education Code 44.034

Texas Education Code, Section 44.034, Notification of Criminal History, Subsection (a), states, "a person or business entity that enters into a contract with a school district must give advance notice to the district if the person or an owner or operator of the business entity has been convicted of a felony. The notice must include a general description of the conduct resulting in the conviction of a felony."

Subsection (b) states, "a school district may terminate a contract with a person or business entity if the district determines that the person or business entity failed to give notice as required by Subsection (a) or misrepresented the conduct resulting in the conviction. The district must compensate the person or business entity for services performed before the termination of the contract."

Subsection (c) states, "This section does not apply to a publicly held corporation."

Vendor certifies one of the following:

- A. My firm is a publicly held corporation; therefore, this reporting requirement is not applicable, or;
- B. My firm is not owned nor operated by anyone who has been convicted of a felony, or;
- C. My firm is owned or operated by the following individual(s) who has/have been convicted of a felony.

If Vendor responds with Option (C), Vendor is required to provide information in the next attribute.

64 Felony Conviction Notice - Texas Education Code 44.034 - Continued

If Vendor selected Option (C) in the previous attribute, Vendor must provide the following information herein:

1. Name of Felon(s)
2. The Felon(s) title/role in Vendor's entity, and
3. Details of Felon(s) Conviction(s).

N/A

65 Conflict of Interest Questionnaire Requirement

Vendor agrees that it has looked up, read, and understood the current version of Texas Local Government Code Chapter 176 which generally requires disclosures of conflicts of interests by Vendor hereunder if Vendor:

- (1) has an employment or other business relationship with a local government officer of our local governmental entity, or a family member of the officer, described by Section 176.003(a)(2)(A);
- (2) has given a local government officer of our local governmental entity, or a family member of the officer, one or more gifts with the aggregate value specified by Section 176.003(a)(2)(B), excluding any gift described by Section 176.003(a-1); or
- (3) has a family relationship with a local government officer of our local governmental entity.
- (4) Any other financial, commercial, or familial relationship with our local government that may warrant reporting under this statute.

Does Vendor certify that it has NO reportable conflict of interest?

Yes, Vendor certifies - VENDOR HAS NO CONFLICT

66 Conflict of Interest Questionnaire Requirement - Form CIQ - Continued

If you responded "No, Vendor does not certify - VENDOR HAS CONFLICT" to the Conflict of Interest Questionnaire question above, you are required by law to fully execute and upload the form attachment entitled "Conflict of Interest Questionnaire - Form CIQ." If you accurately claimed no conflict above, you may disregard the form attachment entitled "Conflict of Interest Questionnaire - Form CIQ."
Have you uploaded this form if applicable?

Not Applicable

67 Upload of Current W-9 Required

Vendors are required by TIPS to upload a current, accurate W-9 Internal Revenue Service (IRS) Tax Form for your entity. This form will be utilized by TIPS to properly identify your entity.

You must confirm that you are responding to this solicitation under your legal entity name. Go now to your Supplier Profile in this eBid System and confirm that your profile reflects your "Legal Name" as it is listed on your W9.

68 Regulatory Good Standing Certification

Does Vendor certify that its entity is in good standing will all government entities and agencies, whether local, state, or federal, that regulate any aspect of Vendor's field of work or business operations?

If Vendor selects "No", Vendor must provide explanation on the following attribute question.

Yes, Vendor certifies

6 **Regulatory Good Standing Certification - Explanation - Continued**

9

If Vendor responded to the prior attribute that "No", Vendor is not in good standing, Vendor must provide an explanation of that lack of good standing here for TIPS consideration.

No response

7 **Instructions Only - Certification Regarding Debarment, Suspension, Ineligibility and Voluntary Exclusion**

0

Instructions for Certification Regarding Debarment, Suspension, Ineligibility and Voluntary Exclusion

1. By answering yes to the next Attribute question below, the vendor and prospective lower tier participant is providing the certification set out herein in accordance with these instructions.
2. The certification in this clause is a material representation of fact upon which reliance was placed when this transaction was entered into. If it is later determined that the prospective lower tier participant knowingly rendered an erroneous certification in addition to other remedies available to the federal government, the department or agency with which this transaction originated may pursue available remedies, including suspension and / or debarment.
3. The prospective lower tier participant shall provide immediate written notice to the person to which this proposal is submitted if at any time the prospective lower tier participant learns that its certification was erroneous when submitted or has become erroneous by reason of changed circumstances.
4. The terms "covered transaction," "debarred," "suspended," "ineligible," "lower tier covered transaction," "participants," "person," "primary covered transaction," "principal," "proposal" and "voluntarily excluded," as used in this clause, have the meanings set out in the Definitions and Coverage sections of rules implementing Executive Order 12549. You may contact the person to which this proposal is submitted for assistance in obtaining a copy of those regulations.
5. The prospective lower tier participant agrees by submitting this form that, should the proposed covered transaction be entered into, it shall not knowingly enter into any lower tier covered transaction with a person who is debarred, suspended, declared ineligible or voluntarily excluded from participation in this covered transaction, unless authorized by the department or agency with which this transaction originated.
6. The prospective lower tier participant further agrees by submitting this form that it will include this clause titled "Certification Regarding Debarment, Suspension, Ineligibility and Voluntary Exclusion-Lower Tier Covered Transaction" without modification in all lower tier covered transactions and in all solicitations for lower tier covered transactions.
7. A participant in a covered transaction may rely upon a certification of a prospective participant in a lower tier covered transaction that it is not debarred, suspended, ineligible or voluntarily excluded from the covered transaction, unless it knows that the certification is erroneous. A participant may decide the method and frequency by which it determines the eligibility of its principals. Each participant may, but is not required to, check the Nonprocurement List.
8. Nothing contained in the foregoing shall be construed to require establishment of a system of records in order to render in good faith the certification required by this clause. The knowledge and information of a participant is not required to exceed that which is normally possessed by a prudent person in the ordinary course of business dealings.
9. Except for transactions authorized under paragraph 5 of these instructions, if a participant in a covered transaction knowingly enters into a lower tier covered transaction with a person who is suspended, debarred, ineligible or voluntarily excluded from participation in this transaction, in addition to other remedies available to the federal government, the department or agency with which this transaction originated may pursue available remedies, including suspension and / or debarment.

7
1 **Suspension or Debarment Certification**

Read the instructions in the attribute above and then answer the following accurately.

Vendor certifies that neither it nor its principals are presently debarred, suspended, proposed for debarment, declared ineligible, or voluntarily excluded from participation in this transaction by any Federal department or agency.

Does Vendor certify?

7
2 **Vendor Certification of Criminal History - Texas Education Code Chapter 22**

Texas Education Code Chapter 22 requires entities that contract with school districts to provide services to obtain criminal history record information regarding covered employees. Contractors must certify to the district that they have complied. Covered employees with disqualifying criminal histories are prohibited from serving at a school district pursuant to this law.

DEFINITIONS

Covered employees: Employees of a contractor or subcontractor who have or will have continuing duties related to the service to be performed at the District and have or will have direct contact with students. The District will be the final arbiter of what constitutes direct contact with students.

Disqualifying criminal history: Any conviction or other criminal history information designated by the District, or one of the following offenses, if at the time of the offense, the victim was under 18 or enrolled in a public school: (a) a felony offense under Title 5, Texas Penal Code; (b) an offense for which a defendant is required to register as a sex offender under Chapter 62, Texas Code of Criminal Procedure; or (c) an equivalent offense under federal law or the laws of another state.

Vendor certifies:

NONE (Section A): None of the employees of Vendor and any subcontractors are covered employees, as defined above. If this box is checked, I further certify that Contractor has taken precautions or imposed conditions to ensure that the employees of Vendor and any subcontractor will not become covered employees. Contractor will maintain these precautions or conditions throughout the time the contracted services are provided under this procurement.

OR

SOME (Section B): Some or all of the employees of Vendor and any subcontractor are covered employees. If this box is checked, I further certify that: (1) Vendor has obtained all required criminal history record information regarding its covered employees. None of the covered employees has a disqualifying criminal history; (2) If Vendor receives information that a covered employee subsequently has a reported criminal history, Vendor will immediately remove the covered employee from contract duties and notify the purchasing entity in writing within 3 business days; (3) Upon request, Vendor will provide the purchasing entity with the name and any other requested information of covered employees so that the purchasing entity may obtain criminal history record information on the covered employees; (4) If the purchasing entity objects to the assignment of a covered employee on the basis of the covered employee's criminal history record information, Vendor agrees to discontinue using that covered employee to provide services at the purchasing entity.

Which option does Vendor certify?

**7
3** Certification Regarding "Choice of Law" Terms with TIPS Members

Vendor agrees that if any "Choice of Law" provision is included in any sales agreement/contract between Vendor and a TIPS Member, that clause must provide that the "Choice of Law" applicable to the sales agreement/contract between Vendor and TIPS Member shall be the state where the TIPS Member operates unless the TIPS Member expressly agrees otherwise. Any TIPS Sale Supplemental Agreement containing a "Choice of Law" clause that conflicts with these terms is rendered void and unenforceable.

If Vendor disagrees, after this solicitation legally closes and TIPS begins evaluating Vendor's file, TIPS will provide Vendor with a draft Word Document version of the Vendor Agreement and will be instructed to include all requested negotiations as redline edits for TIPS consideration.

Does Vendor agree?

**7
4** Certification Regarding "Venue" Terms with TIPS Members

Vendor agrees that if any "Venue" provision is included in any sales agreement/contract between Vendor and a TIPS Member, that clause must provide that the "Venue" for any litigation or alternative dispute resolution is shall be in the state and county where the TIPS Member operates unless the TIPS Member expressly agrees otherwise. Any TIPS Sale Supplemental Agreement containing a "Venue" clause that conflicts with these terms is rendered void and unenforceable.

If Vendor disagrees, after this solicitation legally closes and TIPS begins evaluating Vendor's file, TIPS will provide Vendor with a draft Word Document version of the Vendor Agreement and will be instructed to include all requested negotiations as redline edits for TIPS consideration.

Does Vendor agree?

**7
5** Certification Regarding "Automatic Renewal" Terms with TIPS Members

Vendor agrees that no TIPS Sale may incorporate an "Automatic Renewal" clause that exceeds month to month terms with which the TIPS Member must comply. All renewal terms incorporated into a TIPS Sale Supplemental Agreement shall only be valid and enforceable when Vendor received written confirmation of acceptance of the renewal term from the TIPS Member for the specific renewal term. The purpose of this clause is to avoid a TIPS Member inadvertently renewing a Supplemental Agreement during a period in which the governing body of the TIPS Member has not properly appropriated and budgeted the funds to satisfy the Agreement renewal. Any TIPS Sale Supplemental Agreement containing an "Automatic Renewal" clause that conflicts with these terms is rendered void and unenforceable.

If Vendor disagrees, after this solicitation legally closes and TIPS begins evaluating Vendor's file, TIPS will provide Vendor with a draft Word Document version of the Vendor Agreement and will be instructed to include all requested negotiations as redline edits for TIPS consideration.

Does Vendor agree?

**7
6** Certification Regarding "Indemnity" Terms with TIPS Members

Texas and other jurisdictions restrict the ability of governmental entities to indemnify others. Vendor agrees that if any "Indemnity" provision which requires the TIPS Member to indemnify Vendor is included in any sales agreement/contract between Vendor and a TIPS Member, that clause must either be stricken or qualified by including that such indemnity is only permitted, "to the extent permitted by the laws and constitution of [TIPS Member's State]" unless the TIPS Member expressly agrees otherwise. Any TIPS Sale Supplemental Agreement containing an "Indemnity" clause that conflicts with these terms is rendered void and unenforceable.

If Vendor disagrees, after this solicitation legally closes and TIPS begins evaluating Vendor's file, TIPS will provide Vendor with a draft Word Document version of the Vendor Agreement and will be instructed to include all requested negotiations as redline edits for TIPS consideration.

Does Vendor agree?

**7
7** Certification Regarding "Arbitration" Terms with TIPS Members

Vendor agrees that if any "Arbitration" provision is included in any TIPS Sale agreement/contract between Vendor and a TIPS Member, that clause may **not** require that the arbitration is mandatory or binding. Vendor agrees that if any "Arbitration" provision is included in any TIPS Sale agreement/contract between Vendor and a TIPS Member, that clause provides for only voluntary and non-binding arbitration unless the TIPS Member expressly agrees otherwise. Any TIPS Sale Supplemental Agreement containing a "Arbitration" clause that conflicts with these terms is rendered void and unenforceable.

If Vendor disagrees, after this solicitation legally closes and TIPS begins evaluating Vendor's file, TIPS will provide Vendor with a draft Word Document version of the Vendor Agreement and will be instructed to include all requested negotiations as redline edits for TIPS consideration.

Does Vendor agree?

**7
8** 2 CFR PART 200 AND FEDERAL CONTRACT PROVISIONS EXPLANATION

TIPS and TIPS Members will sometimes seek to make purchases with federal funds. In accordance with 2 C.F.R. Part 200 of the Uniform Administrative Requirements, Cost Principles, and Audit Requirements for Federal Awards (sometimes referred to as "EDGAR"), Vendor's response to the following questions labeled "2 CFR Part 200 or Federal Provision" will indicate Vendor's willingness and ability to comply with certain requirements which may be applicable to TIPS purchases paid for with federal funds, if accepted by Vendor.

Your responses to the following questions labeled "2 CFR Part 200 or Federal Provision" will dictate whether TIPS can list this awarded contract as viable to be considered for a federal fund purchase. **Failure to certify all requirements labeled "2 CFR Part 200 or Federal Provision" will mean that your contract is listed as not viable for the receipt of federal funds. However, it will not prevent award.**

If you do enter into a TIPS Sale when you are accepting federal funds, the contract between you and the TIPS Member will likely require these same certifications.

7 2 CFR Part 200 or Federal Provision - Vendor Willingness to Accept Federal Funds

This certification is not required by federal law. However, TIPS Members are public entities and qualifying non-profits which often receive federal funding and grants (ESSER, CARES Act, EDGAR, etc.) **Accepting such funds often requires additional required certifications and responsibilities for Vendor.** The following attribute questions include these required certifications. Your response to this questions, the following certifications, and other factors will determine whether your contract award will be deemed as eligible for federal fund expenditures by TIPS Members.

If awarded, is Vendor willing to accept payment for goods and services offered under this contract paid for by a TIPS Member with federal funds?

8 2 CFR Part 200 or Federal Provision - Contracts

Contracts for more than the simplified acquisition threshold currently set at \$250,000 (2 CFR § 200.320), which is the inflation adjusted amount determined by the Civilian Agency Acquisition Council and the Defense Acquisition Regulations Council (Councils) as authorized by 41 U.S.C. 1908, must address administrative, contractual, or legal remedies in instances where contractors violate or breach contract terms, and provide for such sanctions and penalties as appropriate.

Notice: Pursuant to the above, when federal funds are expended by ESC Region 8 and TIPS Members, ESC Region 8 and TIPS Members reserve all rights and privileges under the applicable laws and regulations with respect to this procurement in the event of breach of contract by either party.

Does vendor agree?

8 2 CFR Part 200 or Federal Provision - Termination

Termination for cause and for convenience by the grantee or subgrantee including the manner by which it will be effected and the basis for settlement. (All contracts in excess of \$10,000)

Pursuant to the above, when federal funds are expended by ESC Region 8 and TIPS Members, ESC Region 8 and TIPS Members reserve the right to terminate any agreement in excess of \$10,000 resulting from this procurement process for cause after giving the vendor an appropriate opportunity and up to 30 days, to cure the causal breach of terms and conditions. ESC Region 8 and TIPS Members reserve the right to terminate any agreement in excess of \$10,000 resulting from this procurement process for convenience with 30 days notice in writing to the awarded vendor. The Vendor would be compensated for work performed and goods procured as of the termination date if for convenience of the ESC Region 8 and TIPS Members. Any award under this procurement process is not exclusive and the ESC Region 8 and TIPS reserves the right to purchase goods and services from other vendors when it is in the best interest of the ESC Region 8 and TIPS.

Does vendor agree?

8 2 2 CFR Part 200 or Federal Provision - Clean Air Act

Clean Air Act (42 U.S.C. 7401-7671q.) and the Federal Water Pollution Control Act (33 U.S.C. 1251-1387), as amended—Contracts and subgrants of amounts in excess of \$150,000 must contain a provision that requires the non-Federal award to agree to comply with all applicable standards, orders or regulations issued pursuant to the Clean Air Act (42 U.S.C. 7401-7671q) and the Federal Water Pollution Control Act as amended (33 U.S.C. 1251-1387). Violations must be reported to the Federal awarding agency and the Regional Office of the Environmental Protection Agency (EPA).

Pursuant to the Clean Air Act, et al above, when federal funds are expended by ESC Region 8 and TIPS Members, ESC Region 8 and TIPS Members require that the proposer certify that during the term of an award by the ESC Region 8 and TIPS Members resulting from this procurement process the vendor agrees to comply with all of the above regulations, including all of the terms listed and referenced therein.

Does vendor agree?

Yes, Vendor agrees

8 3 2 CFR Part 200 or Federal Provision - Byrd Anti-Lobbying Amendment

Byrd Anti-Lobbying Amendment (31 U.S.C. 1352)—Contractors that apply or bid for an award exceeding \$100,000 must file the required certification. Each tier certifies to the tier above that it will not and has not used Federal appropriated funds to pay any person or organization for influencing or attempting to influence an officer or employee of any agency, a member of Congress, officer or employee of Congress, or an employee of a member of Congress in connection with obtaining any Federal contract, grant or any other award covered by 31 U.S.C. 1352. Each tier must also disclose any lobbying with non-Federal funds that takes place in connection with obtaining any Federal award. Such disclosures are forwarded from tier to tier up to the non-Federal award.

Pursuant to the above, when federal funds are expended by ESC Region 8 and TIPS Members, ESC Region 8 and TIPS Members require the proposer certify that during the term and during the life of any contract with ESC Region 8 and TIPS Members resulting from this procurement process the vendor certifies that it is in compliance with all applicable provisions of the Byrd Anti-Lobbying Amendment (31 U.S.C. 1352).

Does Vendor agree?

Yes, Vendor agrees

8 4 2 CFR Part 200 or Federal Provision - Byrd Anti-Lobbying Amendment - Continued

Applicable to Grants, Subgrants, Cooperative Agreements, and Contracts Exceeding \$100,000 in Federal Funds

Submission of this certification is a prerequisite for making or entering into this transaction and is imposed by the Byrd Anti-Lobbying Amendment (31 U.S.C. 1352). This certification is a material representation of fact upon which reliance was placed when this transaction was made or entered into. Any person who fails to file the required certification shall be subject to a civil penalty of not less than \$10,000 and not more than \$100,000 for each such failure.

The undersigned certifies, to the best of his or her knowledge and belief, that:

(1) No Federal appropriated funds have been paid or will be paid by or on behalf of the undersigned, to any person for influencing or attempting to influence an officer or employee of any agency, a Member of Congress, an officer or employee of congress, or an employee of a Member of Congress in connection with the awarding of a Federal contract, the making of a Federal grant, the making of a Federal loan, the entering into a cooperative agreement, and the extension, continuation, renewal, amendment, or modification of a Federal contract, grant, loan, or cooperative agreement.

(2) If any funds other than Federal appropriated funds have been paid or will be paid to any person for influencing or attempting to influence an officer or employee of any agency, a Member of Congress, an officer or employee of congress, or an employee of a Member of Congress in connection with this Federal grant or cooperative agreement, the undersigned shall complete and submit Standard Form-LLL, "disclosure Form to Report Lobbying," in accordance with its instructions.

(3) The undersigned shall require that the language of this certification be included in the award documents for all covered subawards exceeding \$100,000 in Federal funds at all appropriate tiers and that all subrecipients shall certify and disclose accordingly.

Does Vendor certify that it has NOT lobbied as described herein?

Yes, Vendor certifies - NO Reportable Lobbying

8 5 2 CFR Part 200 or Federal Provision - Byrd Anti-Lobbying Amendment - Continued

If you answered "No, Vendor does not certify - Lobbying to Report" to the above attribute question, you must download, read, execute, and upload the attachment entitled "Disclosure of Lobbying Activities - Standard Form - LLL", as instructed, to report the lobbying activities you performed or paid others to perform.

8 6 2 CFR Part 200 or Federal Provision - Federal Rule

Compliance with all applicable standards, orders, or requirements issued under section 306 of the Clean Air Act (42 U.S.C. 1857(h)), section 508 of the Clean Water Act (33 U.S.C. 1368), Executive Order 11738, and Environmental Protection Agency regulations (40 CFR part 15). (Contracts, subcontracts, and subgrants of amounts in excess of \$100,000)

Pursuant to the above, when federal funds are expended by ESC Region 8 and TIPS Members, ESC Region 8 and TIPS Members requires the proposer certify that in performance of the contracts, subcontracts, and subgrants of amounts in excess of \$250,000, the vendor will be in compliance with all applicable standards, orders, or requirements issued under section 306 of the Clean Air Act (42 U.S.C. 1857(h)), section 508 of the Clean Water Act (33 U.S.C. 1368), Executive Order 11738, and Environmental Protection Agency regulations (40 CFR part 15).

Does vendor certify compliance?

Yes, Vendor certifies

8
7

2 CFR Part 200 or Federal Provision - Procurement of Recovered Materials

A non-Federal entity that is a state agency or agency of a political subdivision of a state and its contractors must comply with section 6002 of the Solid Waste Disposal Act, as amended by the Resource Conservation and Recovery Act. The requirements of Section 6002 include: (1) procuring only items designated in guidelines of the Environmental Protection Agency (EPA) at 40 CFR part 247 that contain the highest percentage of recovered materials practicable, consistent with maintaining a satisfactory level of competition, where the purchase price of the item exceeds \$10,000 or the value of the quantity acquired during the preceding fiscal year exceeded \$10,000; (2) procuring solid waste management services in a manner that maximizes energy and resource recovery; and establishing an affirmative procurement program for procurement of recovered materials identified in the EPA guidelines.

Does vendor certify that it is in compliance with these provisions?

Yes, Vendor certifies

8
8

2 CFR Part 200 or Federal Provision - Rights to Inventions

If the Federal award meets the definition of “funding agreement” under 37 CFR §401.2 (a) and the recipient or subrecipient wishes to enter into a contract with a small business firm or nonprofit organization regarding the substitution of parties, assignment or performance of experimental, developmental, or research work under that “funding agreement,” the recipient or subrecipient must comply with the requirements of 37 CFR Part 401, “Rights to Inventions Made by Nonprofit Organizations and Small Business Firms Under Government Grants, Contracts and Cooperative Agreements,” and any implementing regulations issued by the awarding agency.

Pursuant to the above, when the foregoing applies to ESC Region 8 and TIPS Members, Vendor certifies that during the term of an award resulting from this procurement process, Vendor agrees to comply with all applicable requirements as referenced in the Federal rule above.

Does vendor certify?

Yes, Vendor certifies

8 2 CFR Part 200 or Federal Provision - Domestic Preferences for Procurements and Compliance with
9 Buy America Provisions

As appropriate and to the extent consistent with law, TIPS Member Customers, to the greatest extent practicable under a Federal award, may provide a preference for the purchase, acquisition, or use of goods, products, or materials produced in the United States (including but not limited to iron, aluminum, steel, cement, and other manufactured products). Vendor agrees that the requirements of this section will be included in all subawards including all contracts and purchase orders for work or products under this award, to the greatest extent practicable under a Federal award. For purposes of 2 CFR Part 200.322, "Produced in the United States" means, for iron and steel products, that all manufacturing processes, from the initial melting stage through the application of coatings, occurred in the United States. Moreover, for purposes of 2 CFR Part 200.322, "Manufactured products" means items and construction materials composed in whole or in part of non-ferrous metals such as aluminum, plastics and polymer-based products such as polyvinyl chloride pipe, aggregates such as concrete, glass, including optical fiber, and lumber.

Vendor certifies that it is in compliance with all applicable provisions of the Buy America Act. Purchases made in accordance with the Buy America Act must still follow the applicable procurement rules calling for free and open competition. For purposes of 2 CFR Part 200.322,

"Produced in the United States" means, for iron and steel products, that all manufacturing processes, from the initial melting stage through the application of coatings, occurred in the United States.

"Manufactured products" means items and construction materials composed in whole or in part of non-ferrous metals such as aluminum; plastics and polymer-based products such as polyvinyl chloride pipe; aggregates such as concrete; glass, including optical fiber; and lumber.

Pursuant to the above, when federal funds are expended by ESC Region 8 and TIPS Members, Vendor certifies that to the greatest extent practicable Vendor will provide a preference for the purchase, acquisition, or use of goods, products, or materials produced in the United States (including but not limited to iron, aluminum, steel, cement, and other manufactured products).

Does Vendor Certify?

9 2 CFR Part 200 or Federal Provision - Ban on Foreign Telecommunications
0

ESC 8 and TIPS Members are prohibited from obligating or expending Federal financial assistance, to include loan or grant funds, to: (1) procure or obtain, (2) extend or renew a contract to procure or obtain, or (3) enter into a contract (or extend or renew a contract) to procure or obtain, equipment, services, or systems that use "covered telecommunications" equipment or services as a substantial or essential component of any system, or as critical technology as part of any system. "Covered telecommunications" equipment is telecommunications equipment produced by Huawei Technologies Company or ZTE Corporation (or any subsidiary or affiliate of such entities), and physical security surveillance of critical infrastructure and other national security purposes, and video surveillance and telecommunications equipment produced by Hytera Communications Corporation, Hangzhou Hikvision Digital Technology Company, or Dahua Technology Company (or any subsidiary or affiliate of such entities) for the purpose of public safety, security of government facilities, physical security surveillance of critical infrastructure, and other national security purposes detailed in 2 CFR § 200.216.

Pursuant to the above, when federal funds are expended by ESC Region 8 and TIPS Members, Vendor certifies that Vendor will not purchase equipment, services, or systems that use "covered telecommunications", as defined by 2 CFR §200.216 equipment or services as a substantial or essential component of any system, or as critical technology as part of any system.

Does vendor certify?

9 2 CFR Part 200 or Federal Provision - Contract Cost & Price

1 For contracts more than the simplified acquisition threshold currently set at \$250,000, a TIPS Member may, in very rare circumstances, be required to negotiate profit as a separate element of the price pursuant to 2 C.F.R. 200.324(b). Under those circumstances, Vendor agrees to provide information and negotiate with the TIPS Member regarding profit as a separate element of the price. However, Vendor certifies that the total price charged by the Vendor shall not exceed the Vendor's TIPS pricing and pricing terms proposed.

Does Vendor certify?

Yes, Vendor certifies

9 2 CFR Part 200 or Federal Provision - Equal Employment Opportunity

2 Except as otherwise provided under 41 CFR Part 60, all contracts that meet the definition of "federally assisted construction contract" in 41 CFR Part 60-1.3 must include the equal opportunity clause provided under 41 CFR 60-1.4(b), in accordance with Executive Order 11246, "Equal Employment Opportunity" (30 FR 12319, 12935, 3 CFR Part, 1964-1965 Comp., p. 339), as amended by Executive Order 11375, "Amending Executive Order 11246 Relating to Equal Employment Opportunity," and implementing regulations at 41 CFR part 60, "Office of Federal Contract Compliance Programs, Equal Employment Opportunity, Department of Labor."

Pursuant to the above, when federal funds are expended by ESC Region 8 and TIPS Members on any federally assisted construction contract, the equal

opportunity clause is incorporated by reference here.

Does Vendor Certify?

Yes, Vendor certifies

9 2 CFR Part 200 or Federal Provision - Davis Bacon Act Compliance

3 Texas Statute requires compliance with Davis-Bacon Act, as amended (40 U.S.C. 3141-3148). When required by Federal program legislation, all prime construction contracts in excess of \$2,000 awarded by non-Federal entities must include a provision for compliance with the Davis-Bacon Act (40 U.S.C. 3141-3144, and 3146- 3148) as supplemented by Department of Labor regulations (29 CFR Part 5, "Labor Standards Provisions Applicable to Contracts Covering Federally Financed and Assisted Construction"). In accordance with the statute, contractors must be required to pay wages to laborers and mechanics at a rate not less than the prevailing wages specified in a wage determination made by the Secretary of Labor. In addition, contractors must be required to pay wages not less than once a week. The non- Federal entity must place a copy of the current prevailing wage determination issued by the Department of Labor in each solicitation. The decision to award a contract or subcontract must be conditioned upon the acceptance of the wage determination. The non-Federal entity must report all suspected or reported violations to the Federal awarding agency. The contracts must also include a provision for compliance with the Copeland "Anti-Kickback" Act (40 U.S.C. 3145), as supplemented by Department of Labor regulations (29 CFR Part 3, "Contractors and Subcontractors on Public Building or Public Work Financed in Whole or in Part by Loans or Grants from the United States"). The Act provides that each contractor or subrecipient must be prohibited from inducing, by any means, any person employed in the construction, completion, or repair of public work, to give up any part of the compensation to which he or she is otherwise entitled. The non-Federal entity must report all suspected or reported violations to the Federal awarding agency.

Pursuant to state and federal requirements, Vendor certifies that it will be in compliance with all applicable Davis-Bacon Act provisions if/when applicable.

Does Vendor certify?

Yes, Vendor certifies

9 4 2 CFR Part 200 or Federal Provision - Contract Work Hours and Safety Standards

Where applicable, all contracts awarded by ESC 8 and TIPS Members in excess of \$100,000 that involve the employment of mechanics or laborers must include a provision for compliance with 40 U.S.C. 3702 and 3704, as supplemented by Department of Labor regulations (29 CFR Part 5). Under 40 U.S.C. 3702 of the Act, each contractor must be required to compute the wages of every mechanic and laborer on the basis of a standard work week of 40 hours. Work in excess of the standard work week is permissible provided that the worker is compensated at a rate of not less than one and a half times the basic rate of pay for all hours worked in excess of 40 hours in the work week. The requirements of 40 U.S.C. 3704 are applicable to construction work and provide that no laborer or mechanic must be required to work in surroundings or under working conditions which are unsanitary, hazardous or dangerous. These requirements do not apply to the purchases of supplies or materials or articles ordinarily available on the open market, or contracts for transportation or transmission of intelligence. Pursuant to the above, when federal funds are expended by ESC Region 8 and TIPS Members, Vendor certifies that during the term of an award for all contracts resulting from this procurement process, Vendor will be in compliance with all applicable provisions of the Contract Work Hours and Safety Standards Act.

Does Vendor certify?

Yes, Vendor certifies

9 5 2 CFR Part 200 or Federal Provision - FEMA Fund Certification & Certification of Access to Records

If and when Vendor accepts a TIPS purchase paid for in full or part with FEMA funds, Vendor certifies that:

(1) Vendor agrees to provide the TIPS Member, the FEMA Administrator, the Comptroller General of the United States, or any of their authorized representatives access to and rights to reproduce any books, documents, papers, and records of the Contractor which are directly pertinent to this contract, or any contract resulting from this procurement, for the purposes of making audits, examinations, excerpts, and transcriptions. This right also includes timely and reasonable access to Vendor's personnel for the purpose of interview and discussion relating to such documents. Vendor agrees to provide the FEMA Administrator or an authorized representatives access to construction or other work sites pertaining to the work being completed under the contract. Vendor acknowledges and agrees that no language in this contract or the contract with the TIPS Member is intended to prohibit audits or internal reviews by the FEMA Administrator or the Comptroller General of the United States.

(2) The Vendor shall not use the Department of Homeland Security's seal(s), logos, crests, or reproductions of flags or likenesses of DHS agency officials without specific FEMA pre-approval.

(3) The Vendor will comply with all applicable Federal law, regulations, executive orders, FEMA policies, procedures, and directives.

(4) The Federal Government is not a party to this contract and is not subject to any obligations or liabilities to the non-Federal entity, contractor, or any other party pertaining to any matter resulting from the contract.

(5) The Vendor acknowledges that 31 U.S.C. Chap. 38 (Administrative Remedies for False Claims and Statements) applies to the Vendor's actions pertaining to this contract.

Does Vendor certify?

Yes, Vendor certifies

9 6 2 CFR Part 200 or Federal Provision - Certification of Compliance with the Energy Policy and Conservation Act

When appropriate and to the extent consistent with the law, Vendor certifies that it will comply with the Energy Policy and Conservation Act (42 U.S.C. 6321 et seq; 49 C.F.R. Part 18) and any state mandatory standards and policies relating to energy efficiency which are contained in applicable state energy conservation plans issued in compliance with the Act.

Does Vendor certify?

Yes, Vendor certifies

9 7 2 CFR Part 200 or Federal Provision - Certification of Compliance with Never Contract with the Enemy

Where applicable, all contracts awarded by ESC 8 and TIPS Members in excess of \$50,000.00, within the period of performance, and which are performed outside of the United States, including U.S. territories, are subject to the regulations implementing Never Contract with the Enemy in 2 CFR part 183. Per 2 CFR part 183, in the situation specified, ESC 8 and TIPS Members shall terminate any contract or agreement resulting from this procurement which violates the Never Contract with the Enemy regulation in 2 CFR part 183, including if Vendor is actively opposing the United States or coalition forces involved in a contingency operation in which members of the the Armed Forces are actively engaged in hostilities. Vendor certifies that it is neither an excluded entity under the System for Award Management (SAM) nor Federal Awardee Performance and Integrity Information System (FAPIS) for any contract terminated due to Never Contract with the Enemy as a Termination for Material Failure to Comply.

Does Vendor certify?

Yes, Vendor certifies

9 8 2 CFR Part 200 or Federal Provision - Certification of Compliance with EPA Regulations

For contracts resulting from this procurement, in excess of \$100,000.00 and paid for with federal funds, Vendor certifies that Vendor will comply with all applicable standards, orders, regulations, and/or requirements issued pursuant to the Clean Air Act of 1970, as amended (42 U.S.C. 1857(h)), Section 508 of the Clean Water Act, as amended (33 U.S.C. 1368), Executive Order 117389 and Environmental Protection Agency Regulation, 40 CFR Part 15.

Does Vendor certify?

Yes, Vendor certifies

9 9 2 CFR Part 200 or Federal Provision - Record Retention Requirements

For contracts resulting from this procurement, paid for by ESC 8 or TIPS Members with federal funds, Vendor certifies that Vendor will comply with the record retention requirements detailed in 2 CFR § 200.334. Vendor certifies that Vendor will retain all records as required by 2 CFR § 200.334 for a period of three years after final expenditure or financial reports, as applicable, and all other pending matters are closed.

Does Vendor certify?

Yes, Vendor certifies

1 0 0 2 CFR Part 200 or Federal Provision - Subcontracting and Affirmative Steps for Small and Minority Businesses, Women's Business Enterprises, and Labor Surplus Area Firms.

Do you ever anticipate the possibility of subcontracting any of your work under this award if you are successful?

If you respond "Yes", you must respond to the following attribute question accurately. If you respond "No", you may skip the following attribute question.

YES

1
0
1

2 CFR Part 200 or Federal Provision - If "Yes" Response to Above Attribute - Continued - Subcontracting and Affirmative Steps for Small and Minority Businesses, Women's Business Enterprises, and Labor Surplus Area Firms.

Only respond to this question if you responded "Yes" to the attribute question directly above. Skip this question if you responded "No" to the attribute question directly above.

Does Vendor certify that it will follow the following affirmative steps? Federal Regulation 2 CFR §200.321 Contracting with small and minority businesses, women's business enterprises, and labor surplus area firms. (a)The non-Federal entity must take all necessary affirmative steps to assure that minority businesses, women's business enterprises, and labor surplus area firms are used when possible.

(b) Affirmative steps must include:

- (1) Placing qualified small and minority businesses and women's business enterprises on solicitation lists;
- (2) Assuring that small and minority businesses, and women's business enterprises are solicited whenever they are potential sources;
- (3) Dividing total requirements, when economically feasible, into smaller tasks or quantities to permit maximum participation by small and minority businesses, and women's business enterprises;
- (4) Establishing delivery schedules, where the requirement permits, which encourage participation by small and minority businesses, and women's business enterprises;
- (5) Using the services and assistance, as appropriate, of such organizations as the Small Business Administration and the Minority Business Development Agency of the Department of Commerce ; and
- (6) Requiring the prime contractor, if subcontracts are to be let, to take the affirmative steps listed in paragraphs(1) through (5) of this section.

Does Vendor certify?

1
0
2

ACKNOWLEDGMENT & BINDING CORPORATE AUTHORITY

By submitting this proposal, the individual(s) submitting on behalf of the Vendor certify that they are authorized by Vendor to complete and submit this proposal on behalf of Vendor and that this proposal was duly submitted on behalf of Vendor by authority of its governing body, if any, and within the scope of its corporate powers.

Vendor further certifies that it has read, examined, and understands all portions of this solicitation including but not limited to all attribute questions, attachments, solicitation documents, bid notes, and the Vendor Agreement(s). Vendor certifies that, if necessary, Vendor has consulted with counsel in understanding all portions of this solicitation.

TIPS 240504 Shelters for Storm, Active Shooter, and other Emergencies (2 Part	SunSAFE Film LLC
---	------------------

TIPS REFERENCE FORM

All requested information must be typed and uploaded in Excel format. TIPS will reach out via the emails provided so please ensure that they are typed and accurate. Do not handwrite or upload in any format other than Excel. Emails provided must be current and active. Do not include TIPS/Region 8 employees as a reference. The entities that you provide must be paying customers, not affiliates/partners/manufacturers/recollers, etc.

You must provide below at least five (5) references from five different entity customers, preferably government or non-profit entities, who have purchased goods or services from your vendor entity within the last three years.

Customer Entity Name	Customer Contact Name	Valid Contact Email	Valid Contact Phone
Example: ABC University	Director John Doe	jdove@abcuniverisity.edu	800-111- 2222
KIPP Schools of Texas	Maria Montanio	maria.montanio@kipptexas.org	210-845-4770
Tactura Solutions-Dallas ISD	Jared Hornsby	jared.hornsby@tacturasolutions.com	214-533-7937
Hyatt Regency	Miso Ivanisevic	miso.ivanisevic@hyatt.com	210-510-4315
Avance Schools of San Antonio	Dennis Perez	dennis.perez@avancesa.org	718-404-3562
Riotglass	Dearl Davis	ddavis@riotglass.com	630-857-0175
Metro Methodist Hospital	Abram Buchta	abram.buchta@mhshealth.com	210-389-6054

REQUIRED CONFIDENTIALITY CLAIM FORM

(VENDOR MUST COMPLETE THE FOLLOWING VENDOR INFORMATION)

Vendor Entity Name: Sunsafe Film LLC
Vendor Authorized Signatory Name: Bryan Sleger
Vendor Authorized Signatory Title: Director of Sales
Vendor Authorized Signatory Email: bryan@sunsafefilm.com
Vendor Address: 11703 Huebner Road STE 106-401
City: San Antonio State: TX Zip Code: 78230

Vendor agrees that it is voluntarily providing its data (including but not limited to: Vendor information, Vendor documentation, Vendor's proposal, Vendor pricing submitted or provided to TIPS, TIPS contract documents, TIPS correspondence, Vendor logos and images, Vendor's contact information, Vendor's brochures and commercial information, Vendor's financial information, Vendor's certifications, and any other Vendor information or documentation submitted to TIPS by Vendor and its agents) (Hereinafter, "Vendor Data") to TIPS. Vendor understands and agrees that TIPS is a government entity subject to public information laws including but not limited to Texas Government Code (TGC) Chapter 552. Vendor agrees that regardless of confidentiality designations herein, Vendor's submission of a proposal constitutes Vendor's consent to the disclosure and release of Vendor's Data and comprehensive proposal, including any information deemed confidential or proprietary herein, to and by TIPS Members.

Notwithstanding the foregoing permissible release to TIPS Members, if Vendor considers any portion of Vendor's proposal to be otherwise confidential and not subject to public disclosure pursuant to public information laws, including but not limited to TGC Chapter 552, Vendor must properly execute *Option 1 only* below, attach to this PDF all documents and information that Vendor deems confidential, and upload the consolidated documentation. Regardless of the Option selected below, this form must be completed and uploaded to the "Response Attachments" section of the eBid System entitled "Required Confidentiality Claim Form." Execution and submission of this form is the sole indicator of whether Vendor considers any Vendor Data confidential in the event TIPS receives a request, a Public Information Request, or subpoena. If TIPS receives a request, any responsive documentation not deemed confidential by you through proper execution of Option 1 of this form will be automatically released. For information deemed confidential by you through proper execution of Option 1 of this form, TIPS will follow procedures of controlling statute(s) regarding withholding that documentation and shall not be liable for any release of information required by law, including Attorney General opinion or court order.

(VENDOR MUST COMPLETE ONE OF THE TWO OPTIONS AND UPLOAD IN THE EBID SYSTEM)

OPTION 1 – DESIGNATING CONFIDENTIAL MATERIALS – YES, VENDOR HAS ATTACHED CONFIDENTIAL MATERIALS

OPTION 2 – WAIVER OF CONFIDENTIALITY – NO, VENDOR HAS NOT ATTACHED CONFIDENTIAL MATERIALS

(Confirm each bullet point and sign below)

(Confirm each bullet point and sign below)

- Vendor claims some Vendor Data confidential to the extent permitted by TGC Chapter 552 and other applicable law.
- Vendor attached to this PDF all potentially confidential Vendor Data and listed the number of attached pages below.
- Vendor's authorized signatory has signed below and shall upload this document in the proper location in the eBid System.
- Vendor agrees that TIPS shall not be liable for any release of confidential information required by law.

By signing for Option 2 below, Vendor expressly waives any confidentiality claim for all Vendor Data submitted in relation to this proposal and resulting contract. Vendor confirms that TIPS may freely release Vendor Data submitted in relation to this proposal or resulting contract to any requestor. Vendor agrees that TIPS shall not be responsible or liable for any use or distribution of Vendor Data by TIPS or TIPS Members.

- Vendor's authorized signatory has signed below and shall upload this document in the proper location in the eBid System.
- Vendor agrees that TIPS shall not be liable for any release of confidential information required by law.

Number of pages attached deemed confidential: _____

Authorized Signature: _____

Authorized Signature: Bryan Sleger

VENDOR SUPPLEMENTAL INFORMATION

TIPS permits Vendors to submit supplemental documentation and information (“Vendor Supplemental Information”) with their proposals to display to TIPS Member Customers their qualifications, offerings, and special terms. The following documents are for marketing and informational purposes only. They are not terms of Vendor’s TIPS Contract. If the Vendor Supplemental Information herein contains any warranties, terms, or conditions, the TIPS Member Customer may review and determine whether or not those are applicable and acceptable for any TIPS purchase before proceeding. If the Vendor Supplemental Information contains any licenses or certificates, TIPS encourages the TIPS Member Customer to ensure current accuracy at the time of a TIPS purchase.



PROTECTION FOR
WINDOWS AND GLASS
DOORS



CONTENTS

Our Vision

Problem/Solution

Products

How We Are Different

Case Studies

Leadership

Inspiring the future

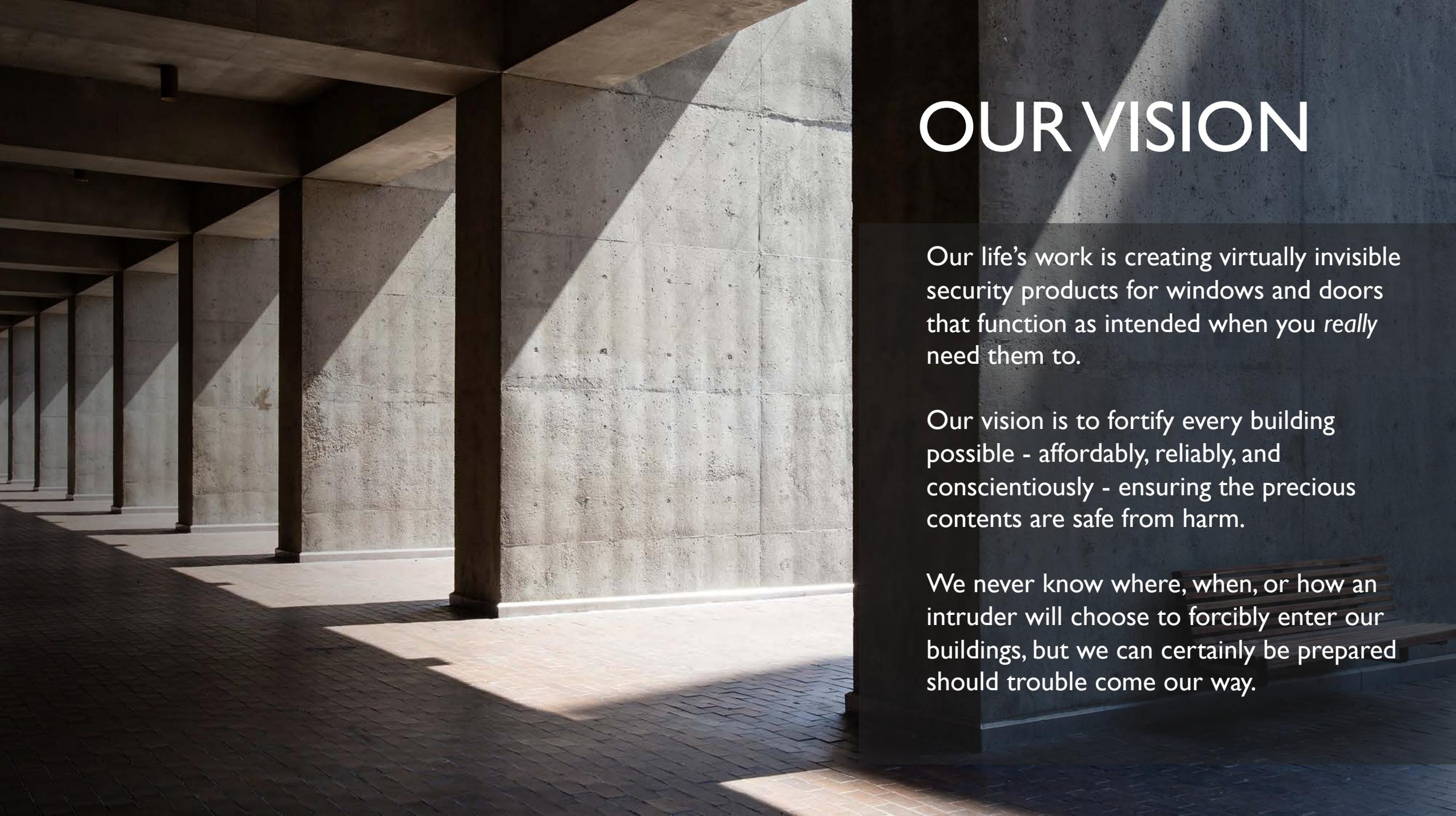

OUR VISION

Our life's work is creating virtually invisible security products for windows and doors that function as intended when you *really* need them to.

Our vision is to fortify every building possible - affordably, reliably, and conscientiously - ensuring the precious contents are safe from harm.

We never know where, when, or how an intruder will choose to forcibly enter our buildings, but we can certainly be prepared should trouble come our way.

THE PROBLEM

- Until recently, solutions that effectively keep intruders out of buildings have been out of range for most budgets.
- Determined intruders have evolved to quickly defeat security window films and standard security glass.
- Bars, scissor gates, and roll-down shutters look bad and are no longer wanted.





THE SOLUTION

Riot Glass is the single solution that:

- Is virtually invisible yet nearly indestructible
- Blends seamlessly in almost any existing window, door, or storefront
- Tests well beyond competing products in terms of strength and durability
- Can be easily retrofitted to reduce installation time and cost

You now have an option that meets high-level security demands while also maintaining an open and inviting look.

Riot Glass In The News



REUTERS

Bloomberg

**BUSINESS
INSIDER**

THE
NEW YORKER

FOX 11 NEWS



CNBC

International media coverage during the 2020 riots started a flood of calls for information and interviews.

OUR CLIENTS



target



ArmorPlast® AP25

AP25 is our flagship product. This virtually invisible glazing shield is mounted in front of your existing windows and glass doors to prevent forced entry.

This system works like an invisible board up that is always there, 24/7 protecting your property.

In many attacks the glass remains unbroken and there is no need for an emergency board up service.

BALLISTIC AND FORCED ENTRY GLASS

Make sure no one can enter or shoot into your building with our RG Series Glass.

We have an incredibly robust line of forced entry and ballistic glass. Available in crystal clear low iron, tinted, or one-way mirror options.

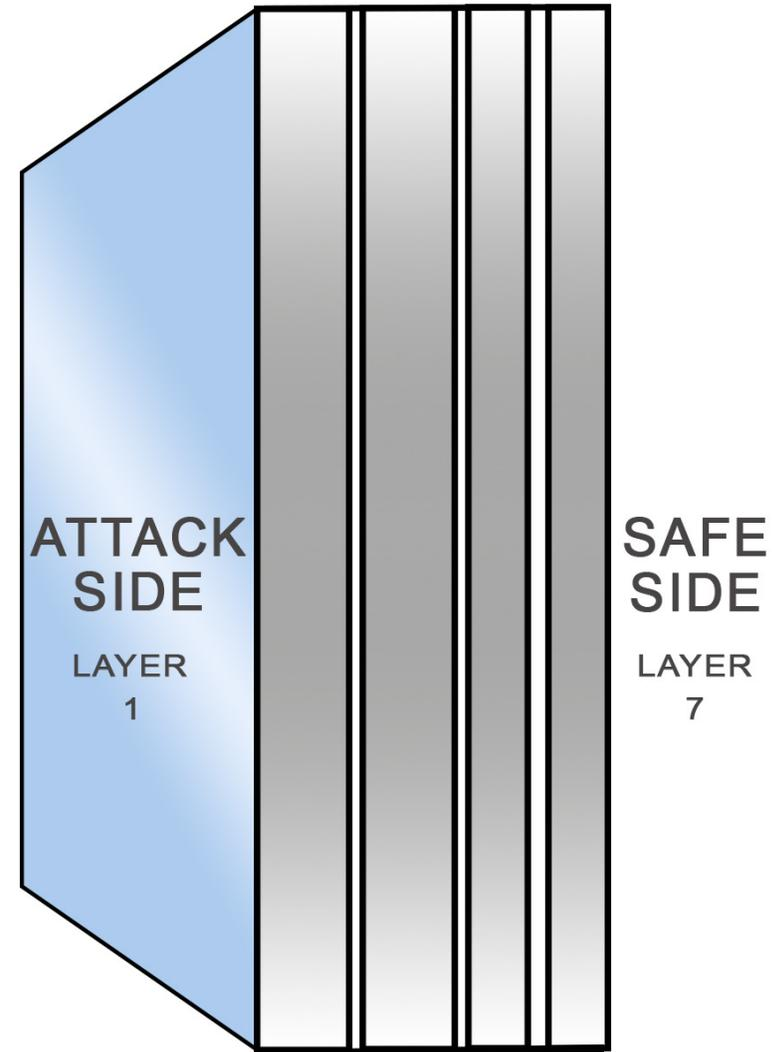

AG SERIES ALL-GLASS DOORS

We combine elegance and style with incredible strength in these precision doors.

AG Series provides options ideal for high-end storefronts and interior spaces.

Available in ballistic and forced entry grades, these doors are designed to meet the stringent demands of both security and design professionals.

You can now have high-level security without compromising aesthetics.

Ballistic Glass

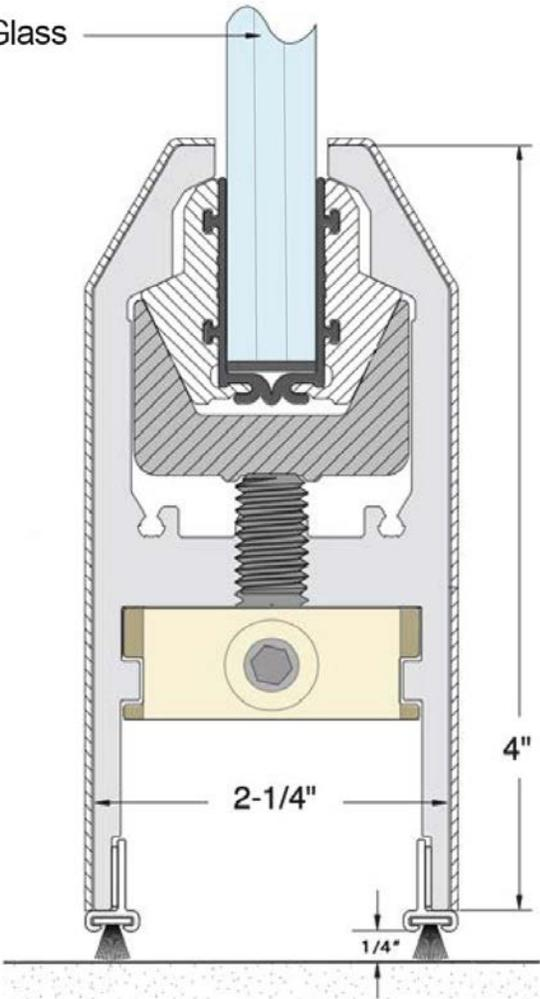

Double Doors



Single Door



HOW WE ARE DIFFERENT

We create groundbreaking products that retrofit into existing glazing to fortify your building. Our patented ArmorPlast systems have received broad national adoption and our brand is focused on improving glass security and the fenestration security space as a whole.

Riot Glass products have an elegant, minimalist appearance that blend seamlessly into existing glazing configurations. Our systems are incredibly strong and adaptable to almost any existing window system in widely varying architectural styles, from ultra-modern to historical properties. Riot Glass is high-level protection designed to thwart the most severe attacks.



Incredibly strong protection



Light weight and fits on most doors and windows



Prevents forced entry in retail, educational, government, and medical facilities



New category of security known as “Access Denial Glazing”



We test relentlessly to ensure every product meets or exceeds expectations

WHO IS THIS FOR?

Riot Glass can be used to secure any building

- Campuses
- Retailers
- Commercial Office Properties
- Government Buildings (GSA/ DOJ)
- Religious Facilities
- Event Centers
- Medical
- Media



OPTIONS

Our ArmorPlast[®] line comes in a variety of strength options to protect against:

- Burglary
- Hurricane
- Human Impact
- Blast
- Looting/ Rioting
- Active Shooter

TIME TO LEVEL UP

Laboratory testing with superior results for bullet resistance, forced entry, Miami-Dade hurricane large missile, human impact, and bomb blast testing*

A new class of protection that allows for fortification without the look of fortification – “invisible steel”

*Blast testing in progress

The Results Speak for Themselves

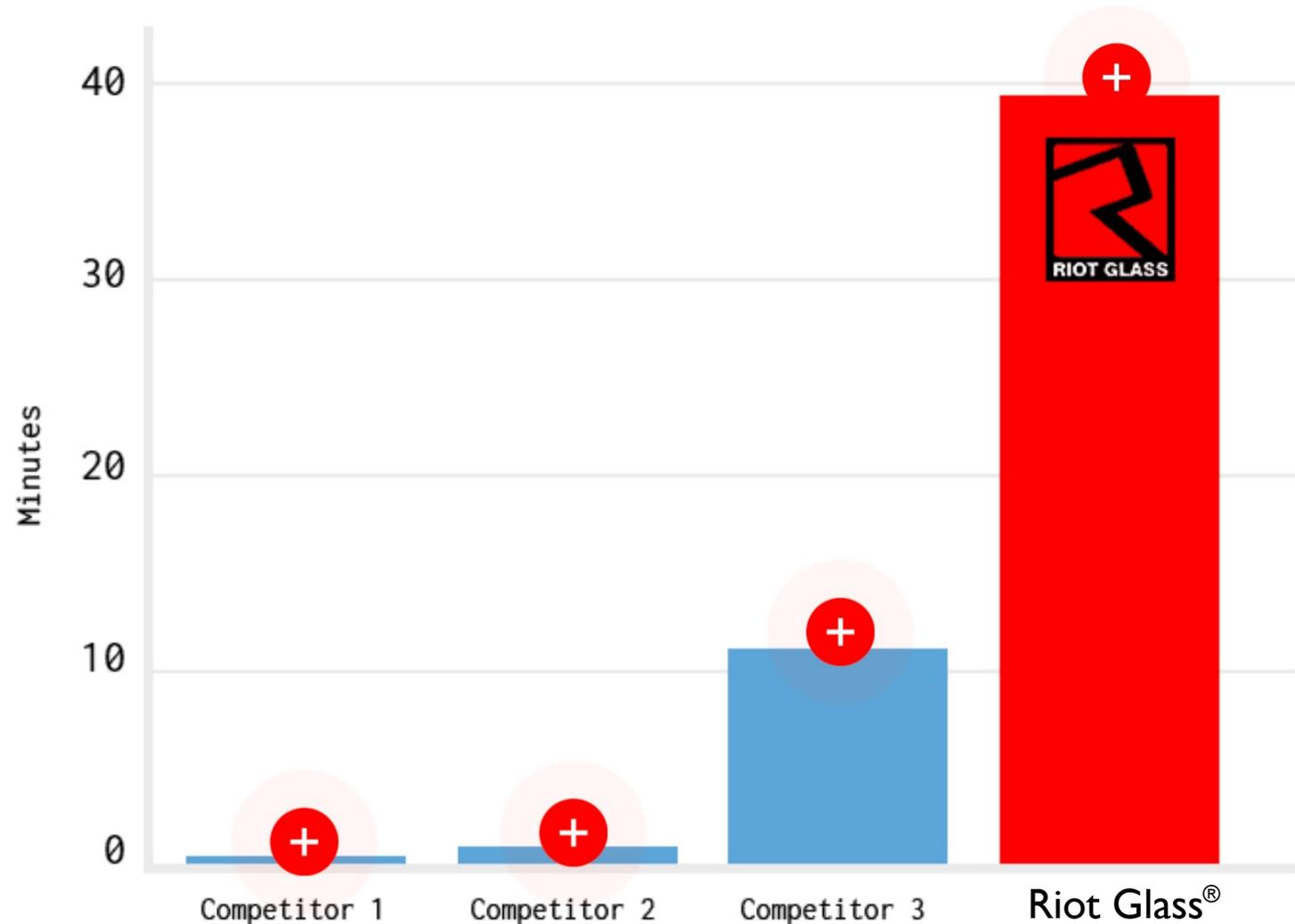

NATIONAL INSTALLATION

Wondering how to get your Riot
Glass installed?

We've got you covered.

Our Authorized Dealer Network
consists of highly skilled glaziers
and specialty contractors that
have passed our stringent
certification process to ensure
you have consistent expert
installation - nationally.



THREE LEVELS OF PROTECTION | YOU'RE BUYING TIME



Security Laminates

30 Sec – 1 Minute

Security film's time delay is comparable to scissor gates, bars, and roll-down shutters

GOOD



AP25 Access Denial

No Entry

BETTER



No Entry + Bullet Resistant

BEST

Riot Glass® and ArmorPlast® are registered trademarks of Riot Glass, Inc

REGULAR GLASS SAYS “PLEASE DON’T COME IN”

- Riot Glass is heavily fortified glass that is becoming the new standard in glazing protection.
- Building occupants need time to react, call 911, run away, or barricade in a safer place.
- You are buying time, and time buys options.



UNPROTECTED
GLASS



BE
FORTIFIED

without

LOOKING
FORTIFIED



Doors are one of the most vulnerable places for forced entry



See Riot Glass[®] in Action!

Click play icons for these 90 second videos

July 2019

19

NO ENTRY



PROTECTED WITH

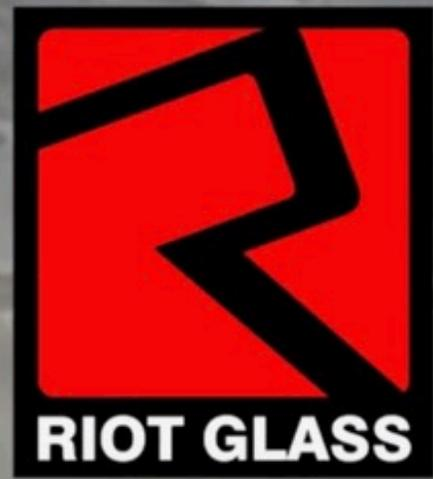

Actual Surveillance Video

Riot Glass vs LA Rioters



Protected By





RIOT GLASS®

BALLISTIC
GLASS SERIES

Our RG Series ballistic glass is made to order. We will work with you to find the perfect glass for your project.



UL 752 Bullet Resistant Materials Standards

Not to Scale	Class Threat Level	Type of Weapon	Caliber & Weight (Grains)	Not to Scale	Ammunition	No. of Shots	Min/Max FPS	Test Range
	1	Handgun	9mm 124 Grain		FMCJ LC	3	1175 1293	4.6 m
	2	Handgun	.357 Magnum 158 Grain		JLSP	3	1250 1375	4.6 m
	3	Handgun	.44 Magnum 240 Grain		LSW GC	3	1350 1485	4.6 m
	4	.30-06 Rifle	.30 Caliber 180 Grain		LCSP	1	2540 2794	4.6 m
	5	AK-47 7.62 Rifle	.308 150 Grain		LC FMCJ Military Ball	1	2750 3025	4.6 m
	6	9mm Uzi	9mm 124 Grain		LC FMCJ	5	1400 1540	4.6 m
	7	AR-15 5.56 Rifle	.223 55 Grain		LC FMCJ	5	3080 3383	4.6 m
	8	AK-47 7.62 Rifle	.308 150 Grain		LC FMCJ Military Ball	5	2750 3025	4.6 m
	9	.30-06 Rifle	.30 Caliber 166 Grain		Steel Core LPF FMJ	1	2715 2987	4.6 m
	10	.50 Caliber Rifle	.50 709.5 Grain		LC FMCJ Military Ball	1	2810 3091	4.6 m
	Shotgun	12 Gauge	Rifled Lead Slug		Loaded 28 g	3	1585 1744	4.6 m
	Shotgun	12 Gauge	00 Buckshot		Loaded 42 g	3	1200 1320	4.6 m

The 2020 murder surge in America, by region

How much murders increased in each region of the US from 2019 to 2020

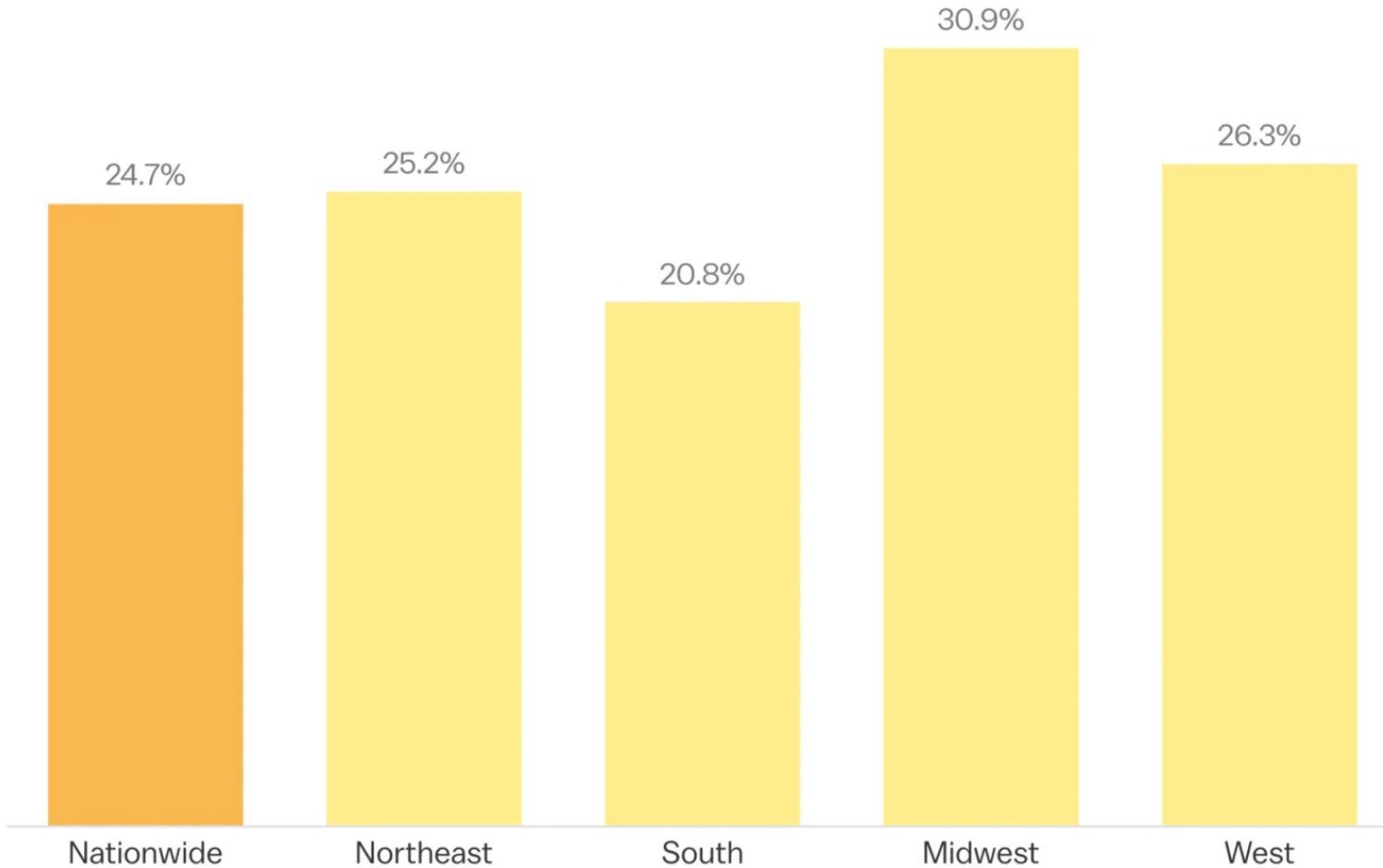

Source: FBI

Vox

VIOLENT CRIME IS ON THE RISE

Many clients are surprised to learn that several of our forced entry glass options are also rated to stop bullets.

WHICH RIOT GLASS DO I NEED?

Statistics show that a large percentage of active shooter events are committed with handguns. These bullets are easier to stop, and our ballistic glass for handguns may be more affordable than you think.



ACTIVE SHOOTER INCIDENTS

2000-2018

Shooters' Weapons

The FBI identified **277** active shooter incidents involving **282** shooters in the U.S. that occurred between 2000 and 2018.

Quick Look:

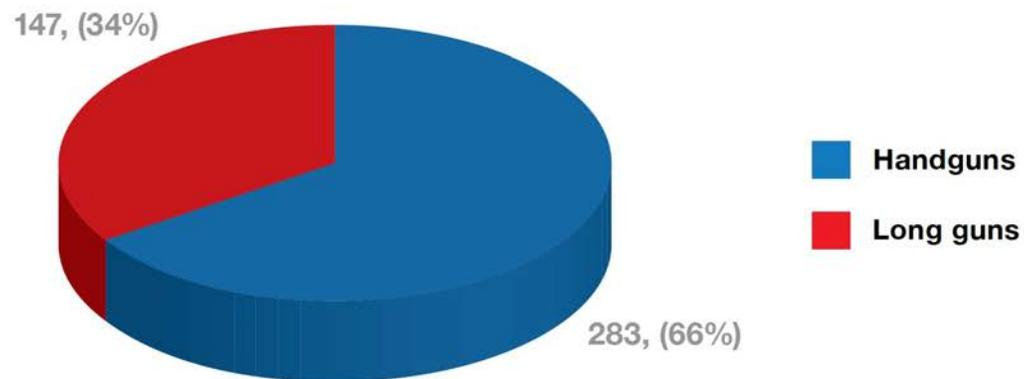

Long guns: 147, 34%. Handguns, 283, 66%.

BALLISTIC GLASS IS BECOMING MORE PREVALENT

Meet the need and stay within budget with affordable Riot Glass value engineered retrofit solutions.



Global Annual Sale in Billions

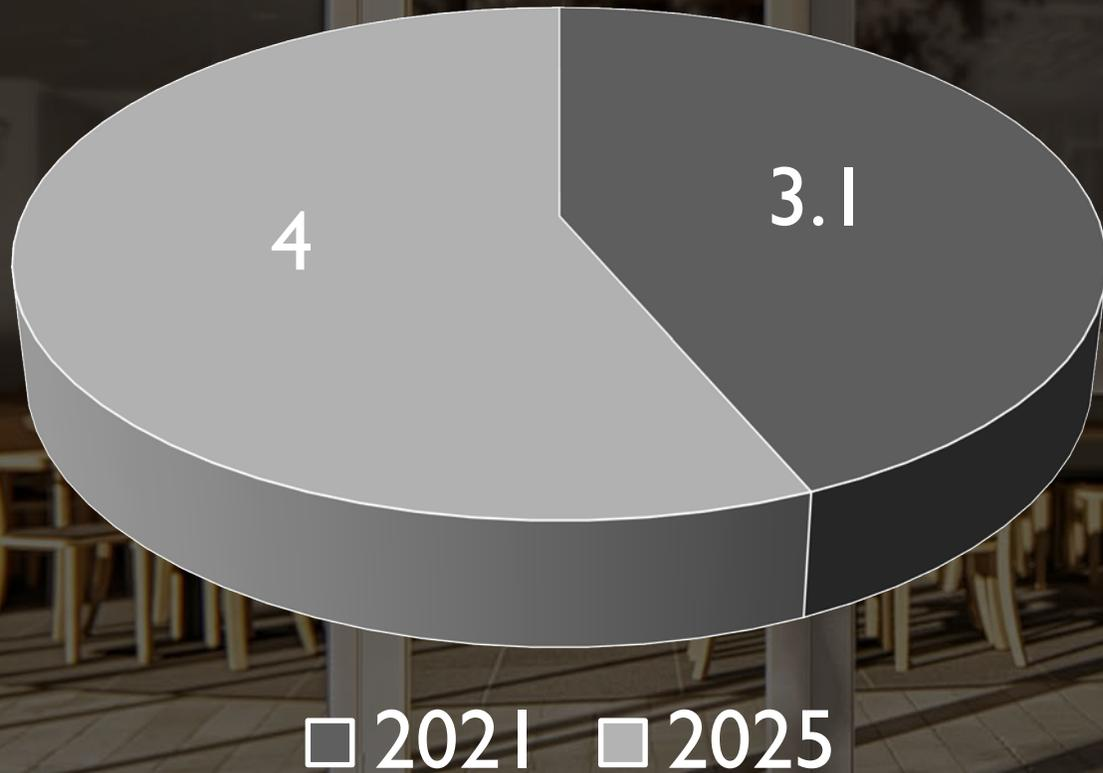

The global bulletproof security glass market is expected to gain growth in the forecast period of 2021 to 2025 with a CAGR of 6.6%. Expectations place global revenue at USD 3.9 billion by 2025, from USD 3.1 billion.



CASE STUDIES



Many top retailers have adopted Riot Glass nationally in hundreds of stores through ongoing rollouts.

HISTORIC PRESERVATION

- Funeral home built 1920
- Homeless repeatedly broke in stealing invaluable items
- Riot Glass installed - no further incidences

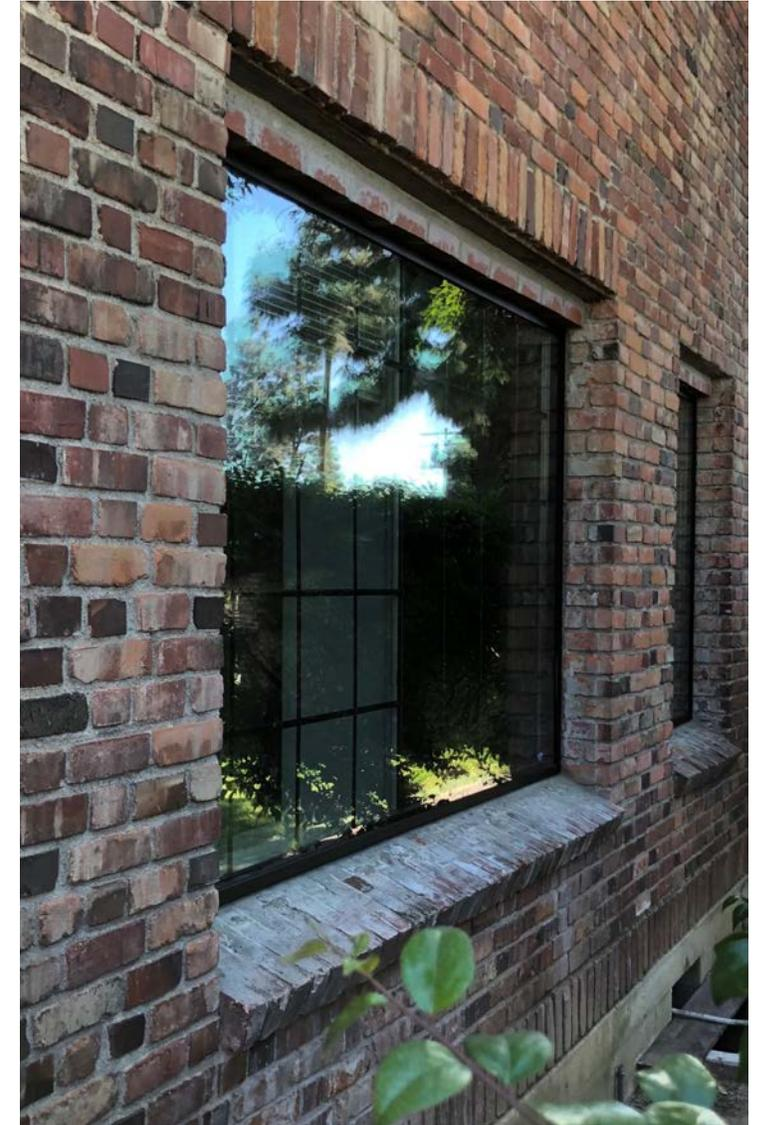



PROTECTION FOR RELIGIOUS FACILITY

- Riot Glass fits on highly vulnerable glass doors with panic egress hardware
- #1 attack point has been the doors
- Used our highly fortified framing with sleeve bolts for added strength
- Maintained sightlines

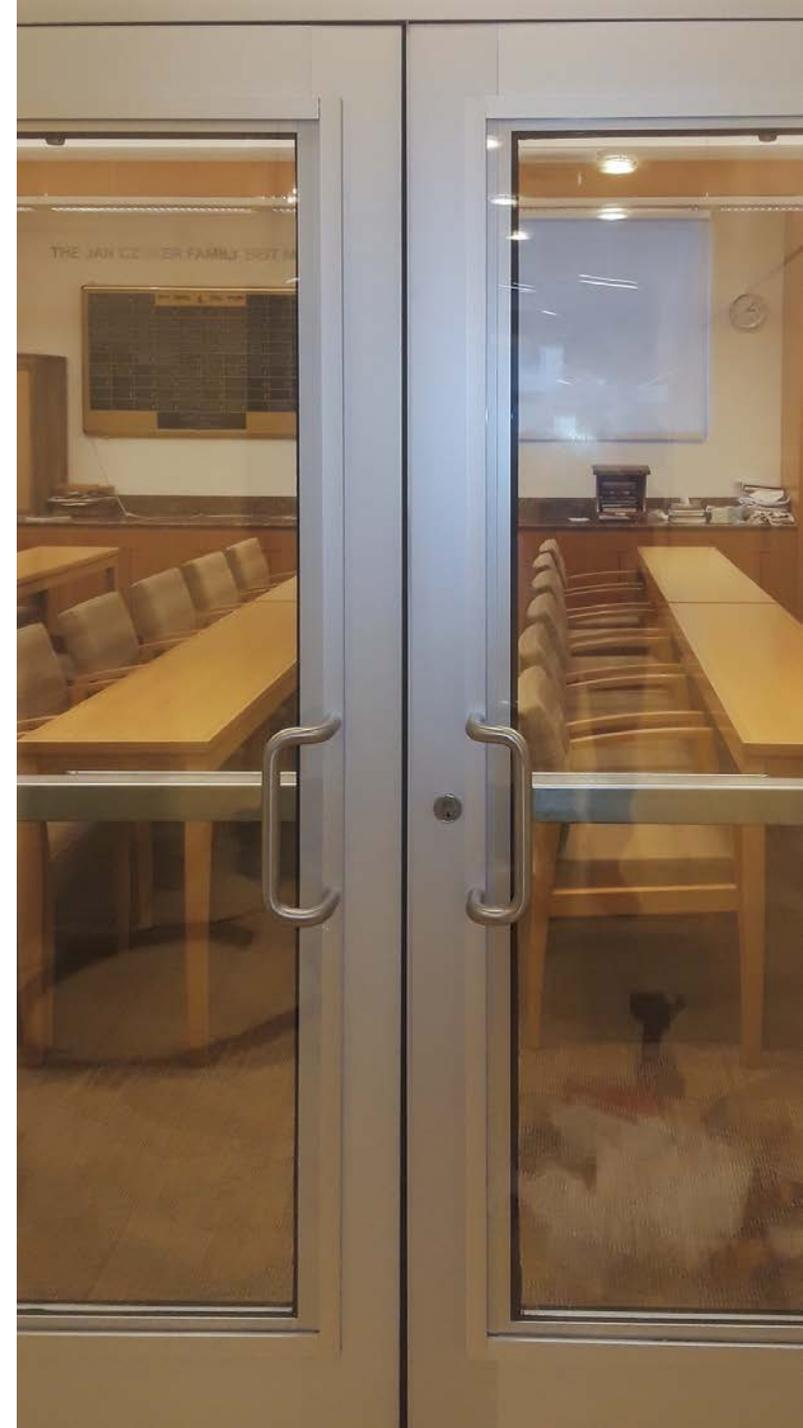



ENGINEERED TO FIT PERFECTLY

International sports media company armors windows with UL Level 4 Riot Glass

BACK GLAZING WITH LARGE PANEL SIZES

Back Glazing (inside) behind existing building glass with low iron 72" x 120" Ballistic Level 4 Riot Glass panels set in our UL rated framing system



RIOT GLASS TESTING

- HP White Laboratory/ ASTM Forced Entry
- Miami-Dade Hurricane Testing – Large Missile Impact
- Human Impact
- UL 752 Ballistic Rated Levels 1-10
- Energy Efficiency
- Blast Mitigation



OUR LEADERSHIP



Scott Beerer
VP Business Development
A natural team builder with a background in Major League Baseball. Key accounts manager and head of new dealer recruitment.



Selina Moore
VP Operations
Eleven-year veteran at Riot Glass, Inc. Has a masterful understanding of project management, estimating, and human resources.



Brad Campbell
CEO
30 years in the fenestration security industry and visionary at Riot Glass, Inc. Our director of new product development.



Terry Green
Head of Engineering
Decades of experience in product development with major glazing manufacturers. CAD, Inventor, & 3D printer modeling of prototypes.

INSPIRING THE FUTURE

Imagine a world without forced entry crimes. Today we have the technology to eliminate significant vulnerabilities in our buildings and change the way we think about glass.

Everyone deserves to wake up each day feeling safe and secure. Together we can protect our communities - striking a balance between strength, reliability, and aesthetics.

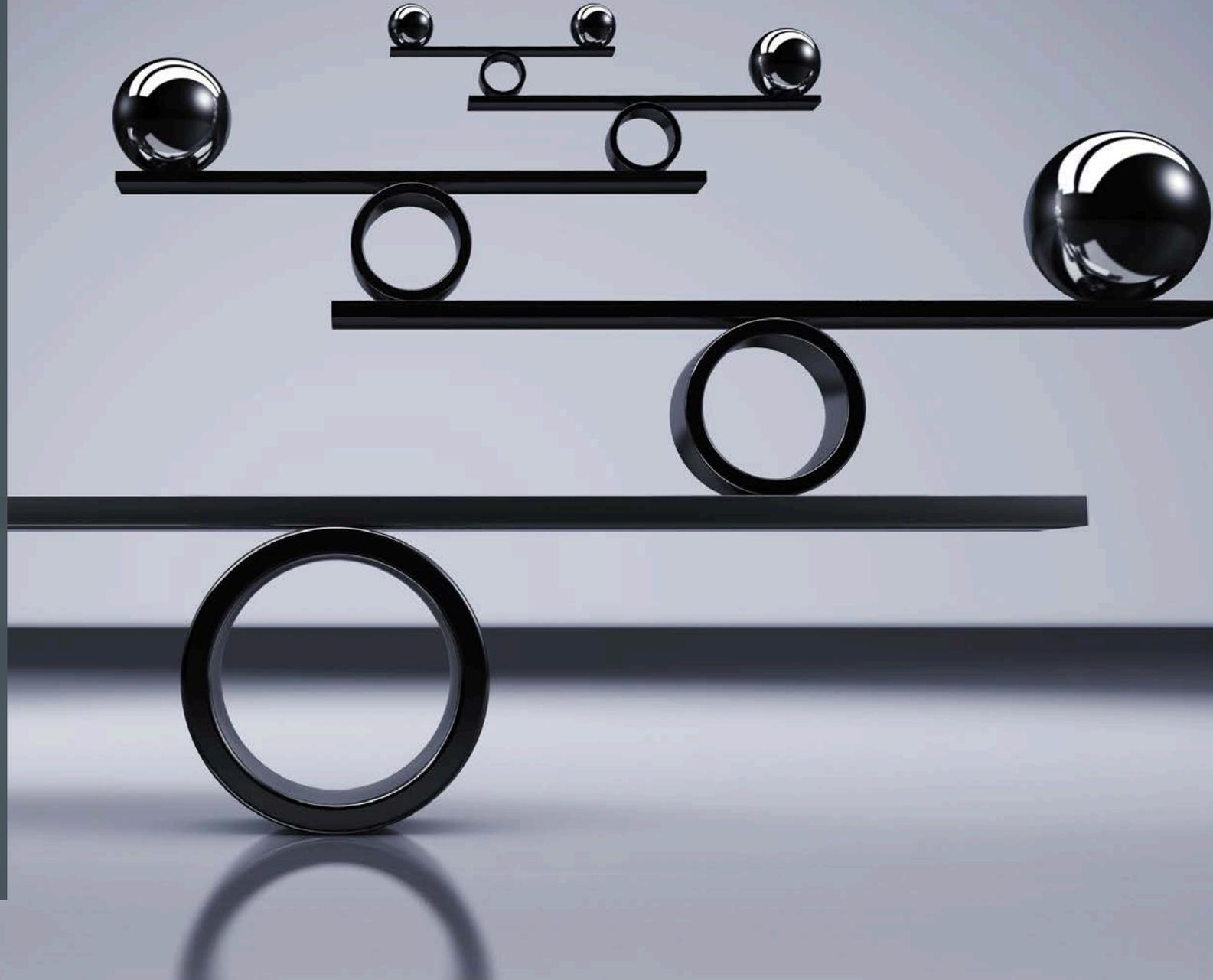



VIRTUALLY INVISIBLE
SECURITY





**READY TO GET
STARTED?**

info@riotglass.com

800-580-2303



Weslaco ISD-RFP 24-05-31

WARRANTY INFORMATION

IMPORTANT: Read this entire Limited Warranty (not transferrable), before purchasing or installing Solargard Armorcoat security film, you acknowledge that this Limited Warranty is part of the terms of sale. Sunsafe may choose to extend Solargard's warranty based on the scope of work and need for greater than 14 year manufacturing warranty. **For all Weslaco ISD campuses-1 additional years of full warranty coverage was added by Sunsafe to bring the total warranty to 15 years on all parts and labor based on the specifications below.**

WARRANTY COVERAGE

Sunsafe warrants professionally sold and installed Solargard brand films to be free from the following. Defects in materials and workmanship: peeling, bubbling, rippling, cracking, adhesive failure, delamination, and demetalization. Sunsafe does not warrant any conditions of, or damage to, the Products other than the conditions described in this Limited Warranty. Warranty time periods vary and are stated on the schedule on the back of this Limited Warranty. PLEASE NOTE IMPORTANT EXCLUSIONS AND PRE-APPROVAL REQUIREMENTS SPECIFIED ON THE REVERSE SIDE OF THIS DOCUMENT.

GLASS BREAKAGE WARRANTY

Except with respect to the exclusion provided below, this Limited Warranty on the Products covers glass breakage due to thermal stress. Sunsafe reserves the right to have a local representative of its choice inspect the affected window(s) before approving claims. Upon approval of a claim at Sunsafe's sole discretion, Sunsafe will pay for glass unit replacement up to a maximum of \$500 per window.

GENERAL PROVISIONS

This Limited Warranty is offered only to the original purchaser at the time of Product installation. This Limited Warranty may not be transferred, sold or assigned. Rental units are considered commercial properties. This Limited Warranty terminates automatically upon any sale, conveyance or change in tenancy of any property. For valid warranty claims, Sunsafe will have an authorized installer of its choice remove and reapply the Product to areas determined by Sunsafe in its sole discretion to be covered by this Limited Warranty, and Sunsafe will cover parts and labor. The replacement of the defective film/glass, including parts and labor, is the exclusive remedy for all Products covered under this Limited Warranty. Payment for labor charges covered by this Limited Warranty will be made directly to the authorized Sunsafe installer and will be calculated by using the coverage allowance published by Sunsafe.

WARRANTY DISCLAIMER; APPLICATION OF LAW

THERE ARE NO WARRANTIES WHICH EXTEND BEYOND THE DESCRIPTION ON THE FACE HEREOF, NOR ARE THERE WARRANTIES OF FITNESS FOR A PARTICULAR PURPOSE OR MERCHANTABILITY APPLICABLE TO THE PRODUCTS. THIS LIMITED WARRANTY DOES NOT COVER CUSTOM PRODUCTS. THIS LIMITED WARRANTY ALSO DOES NOT COVER IMPROPER OR POOR INSTALLATION OF THE PRODUCTS, WHICH INCLUDES BUT IS NOT LIMITED TO SQUEEGEEING, TRIMMING AND MEASURING. TO THE FULLEST EXTENT PERMITTED BY LAW, THIS LIMITED WARRANTY DOES NOT EXTEND TO, AND IN NO EVENT SHALL XPEL OR ANY AUTHORIZED SUNSAFE INSTALLER BE LIABLE FOR, ANY INDIRECT, SPECIAL, INCIDENTAL, EXEMPLARY, CONSEQUENTIAL OR OTHER DAMAGE ARISING OUT OF THE INSTALLATION OR USE OF THE PRODUCT. SOME JURISDICTIONS DO NOT ALLOW THE EXCLUSION OR LIMITATION OF INCIDENTAL OR CONSEQUENTIAL DAMAGES, SO THE ABOVE LIMITATION OR EXCLUSION MAY NOT APPLY TO YOU. THE EXPRESS WARRANTIES AND REMEDIES DESCRIBED ABOVE ARE THE EXCLUSIVE WARRANTIES AND REMEDIES AVAILABLE AND ARE IN LIEU OF ALL OTHER WARRANTIES AND REMEDIES, EXPRESS OR IMPLIED. SUNSAFE HEREBY DISCLAIMS ALL OTHER EXPRESS AND IMPLIED WARRANTIES, INCLUDING THE IMPLIED WARRANTIES OF MERCHANTABILITY AND FITNESS FOR A PARTICULAR PURPOSE. TO THE FULLEST EXTENT PERMITTED BY LAW, IN NO EVENT SHALL SUNSAFE'S LIABILITY EXCEED THE PRICE PAID FOR THE PRODUCT. THIS PROVISION SETS AN UPPER LIMIT TO THE AMOUNT OF DAMAGES, IF ANY, THAT THE OWNER OF THE PRODUCT MAY RECOVER FOR ANY AND ALL CLAIMS AND CAUSES OF ACTION. THIS LIMITED WARRANTY GIVES YOU SPECIFIC LEGAL RIGHTS, AND YOU MAY ALSO HAVE OTHER RIGHTS WHICH VARY FROM JURISDICTION TO JURISDICTION.

TO MAKE A WARRANTY CLAIM

This Limited Warranty is the Product owner's sole and exclusive remedy. To file a warranty claim, you must first submit, within the Limited Warranty period, this warranty card and a copy of your original receipt for the Product identifying coverage areas, along with a detailed description of the purported defect to the authorized Sunsafe installer who performed the installation of the Product, or in the event you are unable to contact the original authorized Sunsafe installer, to Sunsafe at the address below. All warranty claims must include the claimant's name, phone number, address and the installation address (if different). All warranty claims must be approved by Sunsafe, and Sunsafe has the sole authority and discretion to determine the validity of all claims. Sunsafe reserves the right to deny claims that do not meet the criteria or are otherwise excluded as described above. For more information on this Limited Warranty, call the toll-free telephone number listed below.

Product number: Solargard Armorcoat Run Number: D166324548-003-B SQ Ft Covered: <10,000